

**FINEST QUALITY**

*Union Special*<sup>®</sup>  
LEWIS • COLUMBIA

**INDUSTRIAL  
SEWING  
MACHINES**

THE EDGELOCK MACHINES  
FORTH-THREE THOUSAND SERIES

LIST OF PARTS  
FOR  
STYLE 43200 G

**STYLE  
43200G**

Supplementary Catalog No. 75 N

Catalog No. 75 N applies only to machines with serial numbers higher than 293000 and includes all parts in Style 43200 G that are not included in Catalog No. 75 L.

**CATALOG  
No. 75N**

*Union Special* MACHINE COMPANY

The Edgelock Machines

Forty-Three Thousand Series

Supplementary Catalog No. 75 N

List of Parts for

Style 43200 G

Description of Style 43200 G

For hemming overalls, jackets, and similar garments, high throw, two needle bar bearings; stitching Type Efb-1, hem turned on under surface of fabric, Type 128 needle, stitch range 16 to 8 per inch, split hemming attachment and knee press for opening same, standard widths of hem  $3/8$  and  $1/2$  inch.

Copyright 1938

By

Union Special Machine Co.  
Rights Reserved In All Countries

Union Special Machine Company  
U.S.A.

Printed in U.S.A.

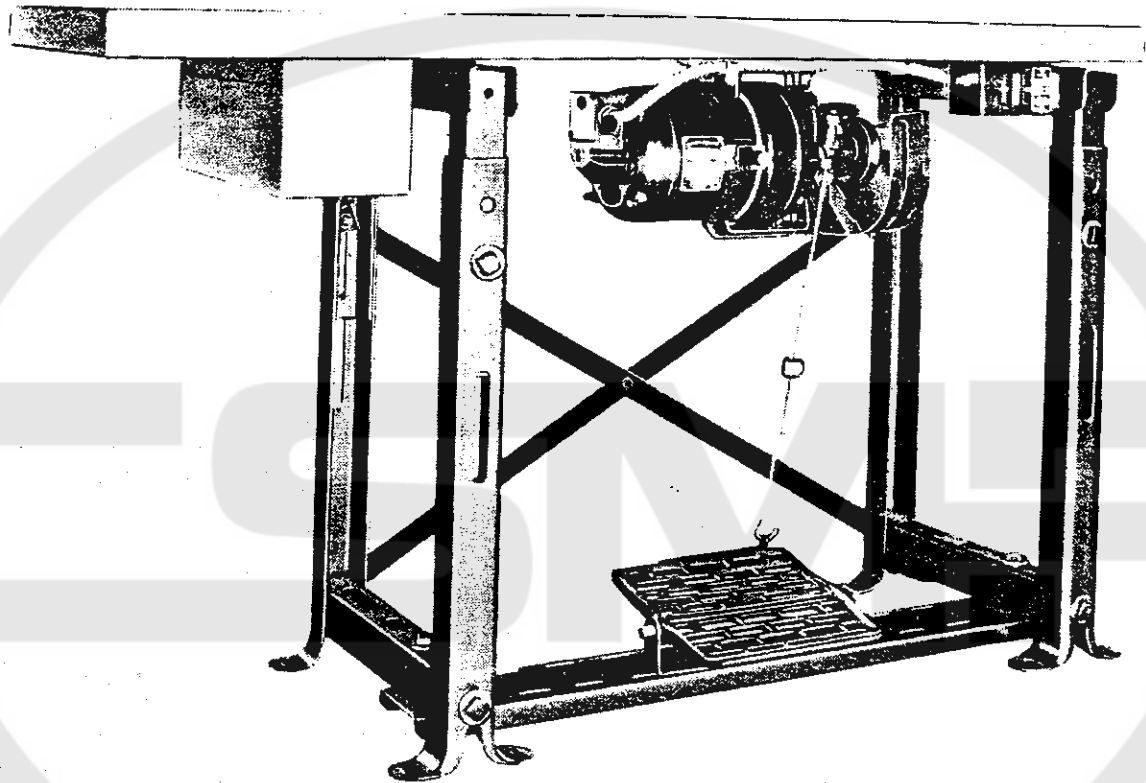

**"Electro Drive"**

Table Top, drawer, stand, and treadle are shown only  
for clarity and are furnished separately.

Plate 1 - Full Size

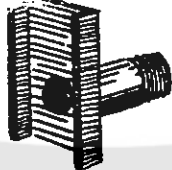
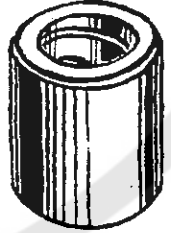
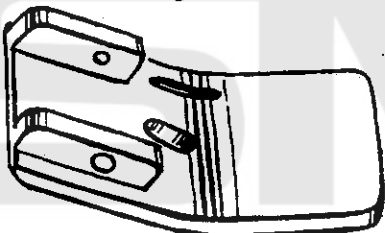
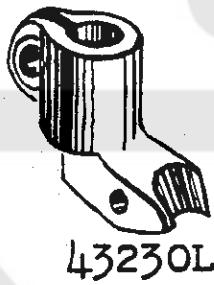
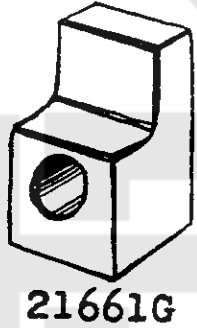
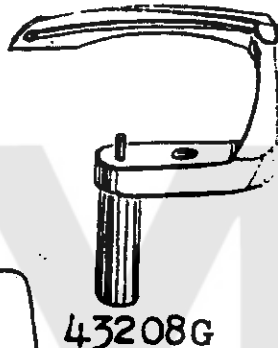
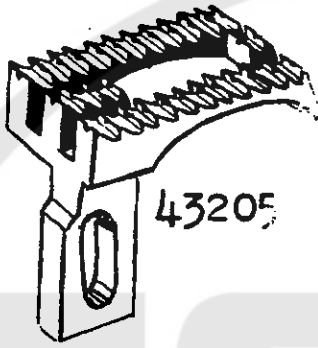
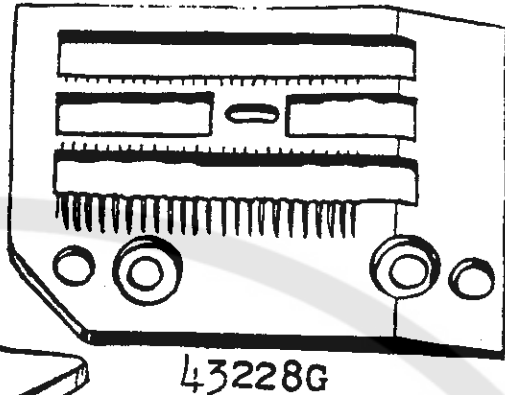
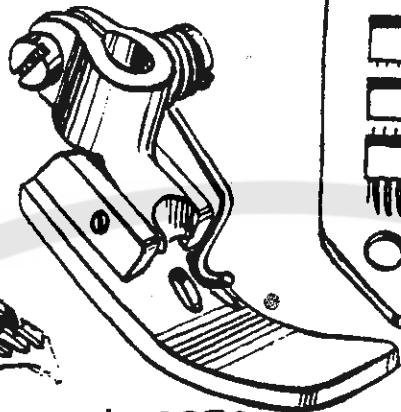

51292 F-2

43243N

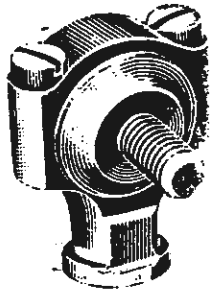
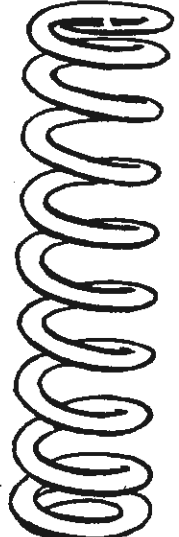
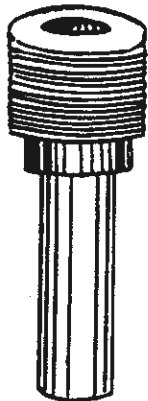

Plate 2 - Full Size

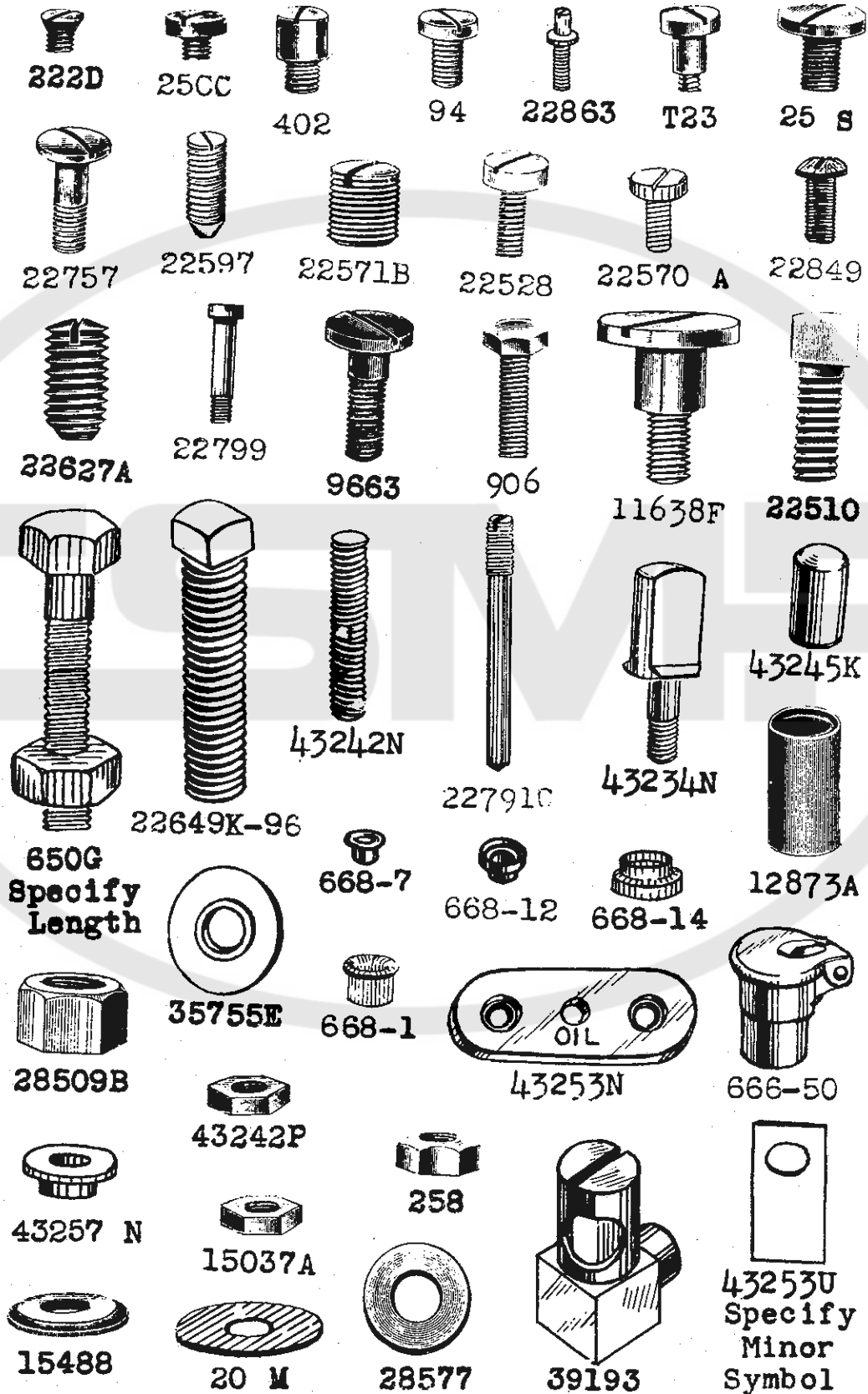
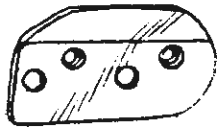
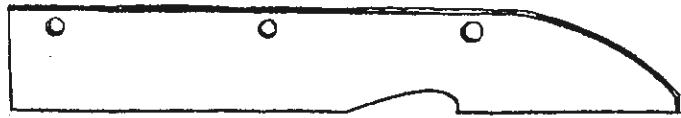

Plate 3 - One-Half Size



43282A



43283B

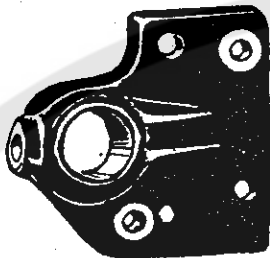

43245J

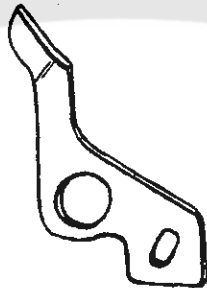

43255G

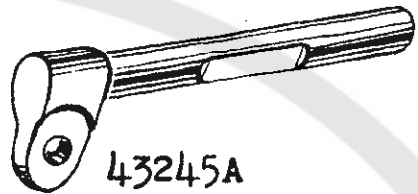

43245A

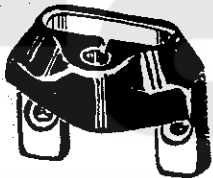

43253G

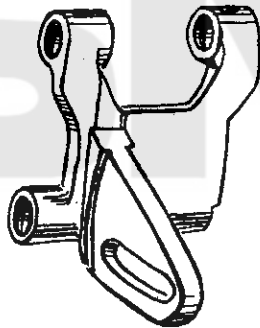

43240

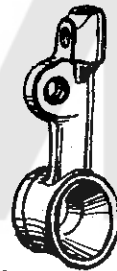

43213G

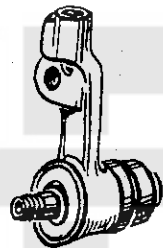

29192H



43234U

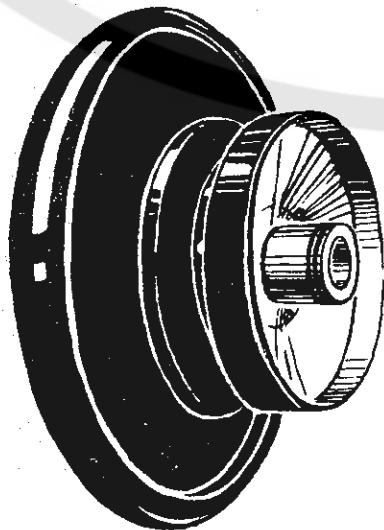

43221

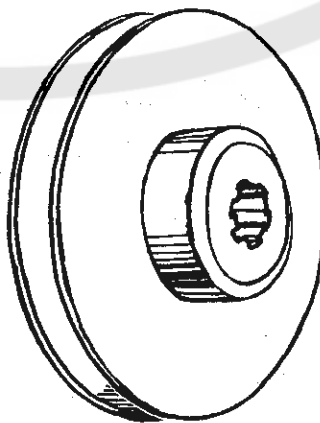

28602S  
Specify  
Diameter

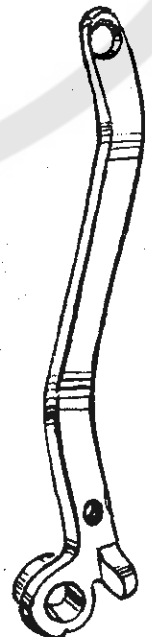

43255B

Plate 4 - One-Half Size

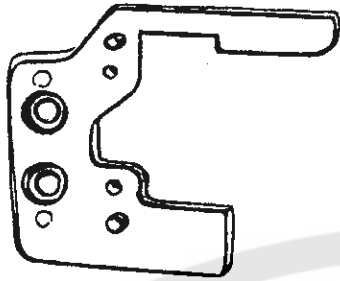

43280B

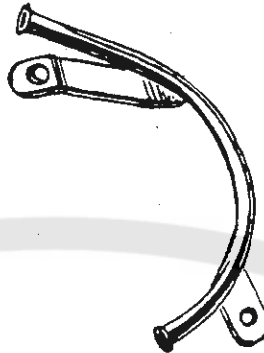

43264G



43245D



666-79



43242A

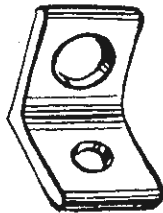

43255N

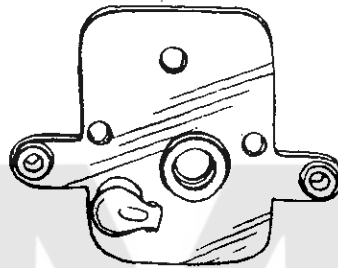

43265A

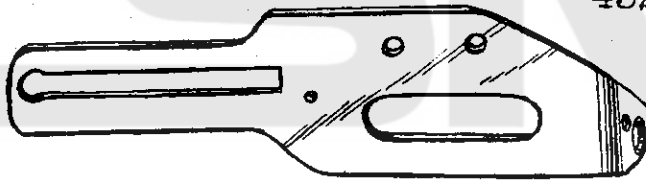

23364AB



28504

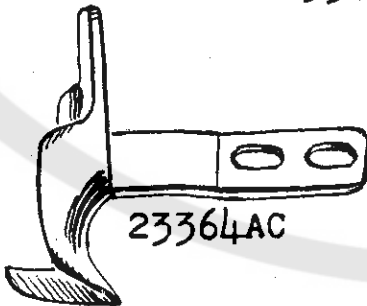

23364AC



23425V

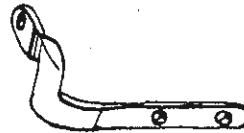

23364AF

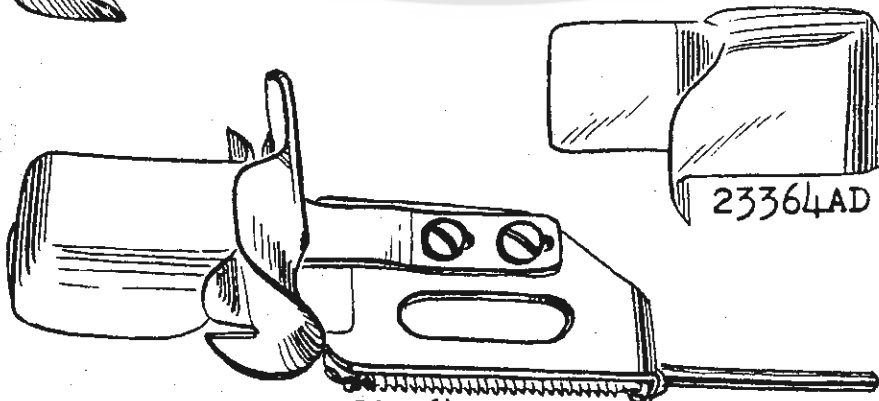

23364AA

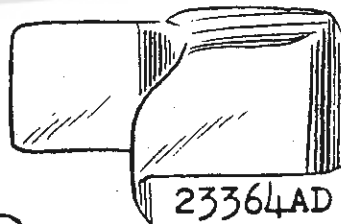

23364AD



23364AE

Plate 5 - One-Half Size

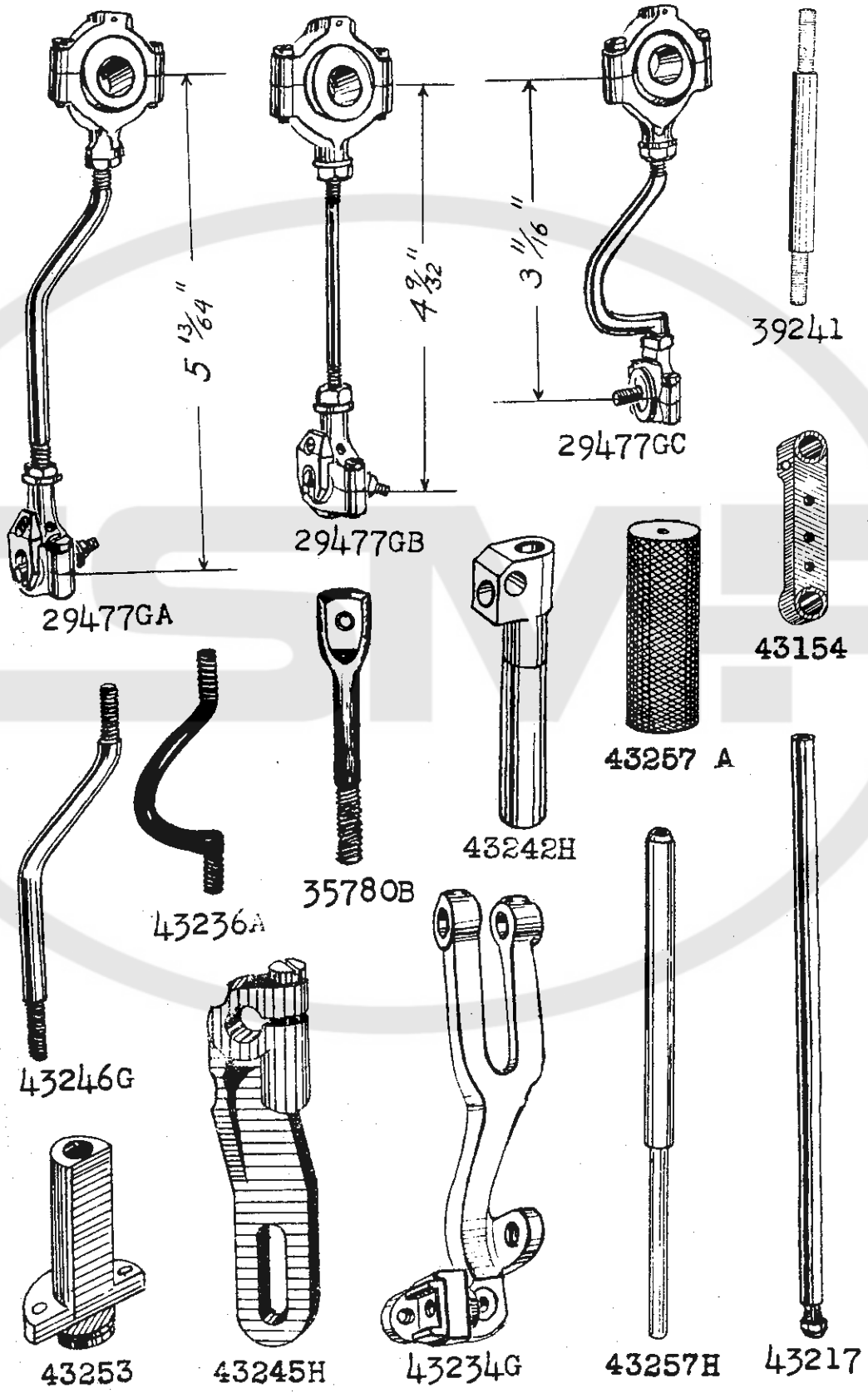
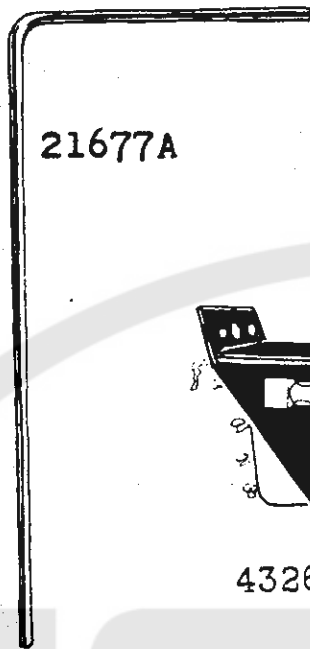
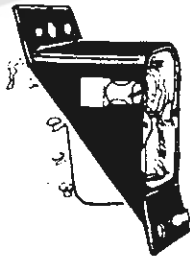



Plate 6 - One-Fourth Size



21677A



43262N

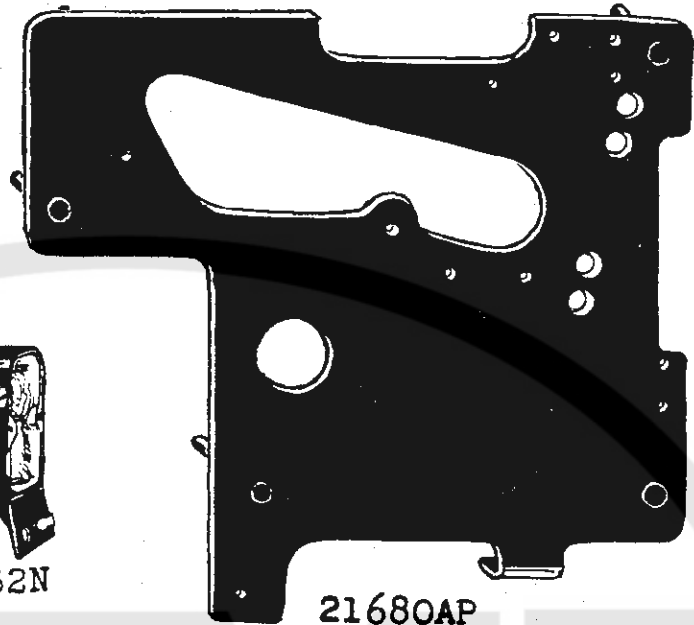

21680AP



43283A



43261A



21661F



21104 B  
Specify  
Length



43294F

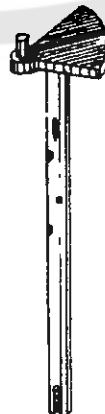

43122



43281N

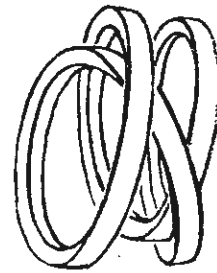

21262H  
Specify Length

Plate 7 - One-Eighth Size



28578B

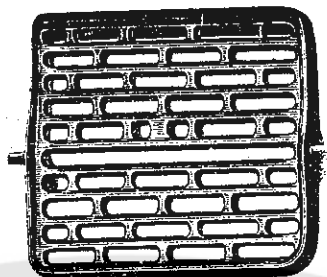

28575



21697U



43262J



28576B



21375AP

LIST OF PARTS

Symbol to Order by	The figures in the last column refer only to the plates illustrating the parts and are not to be used in ordering. Refer to pink insert for prices.	Plate No.
20 M	Washer, for knee press lever- - - - -	2
T23	Screw, for presser foot spring- - - - -	2
25 S	" for hemmer - - - - -	2
25 CC	" for belt guard, also for No. 43281 N	2
94	" for needle thread tension disc separator- - - - -	2
222 D	" for main oil reservoir cover - - - -	2
258	Nut, for knee press lever, also for No. 35780 B - - - - -	2
402	Lifter Lever Stop Pin - - - - -	2
650 G-12	Machine Bolt, hexagonal head, 5/16 x 1 1/2 inches, for attaching "Electro Drive" to belt take-up assembly - - - - -	2
652-12	Washer, 3/16 inch, for belt guard screws on "Electro Drive" installations - - - - -	-
652 A-20	Lock Washer, 5/16 inch, for attaching "Electro Drive" to belt take-up assembly - - - - -	-
666-50	Oil Cup, for main oil reservoir cover - - -	2
666-79	Oil Cup Assembly, with sight feed and signal stop - - - - -	4
668-1	Porcelain Eyelet, for oil reservoir cover	2
668-7	Porcelain Insert, for tension thread eyelet	2
668-12	Porcelain Insert Locking Ferrule, for tension thread eyelet- - - - -	2
668-14	Porcelain Insert Locking Ferrule, for oil reservoir cover - - - - -	2
906	Screw, for feed bar guiding stud fork - - -	2
9663	" for throat plate support bracket - - -	2
11638 F	" for knee press lever - - - - -	2
12873 A	Needle Bar Bushing- - - - -	2
15037 A	Nut, for feed lift ball joint stud, also for No. 43242 N - - - - -	2
15488	Washer, for looper drive shaft arm ball joint - - - - -	2
21104 B-5	Belt Take-up Hanger Pivot Shaft, 5 inches long (set screw No. 22627 A)- - - - -	6
21104 B-9	Thread Stand Rod, 9 inches long (screw No. 22509)- - - - -	6
21262 H-350	"V" Belt, No. 2 size, 35 inches long- - - -	6
21262 H-370	"V" Belt, 37 inches long- - - - -	6
21262 H-390	"V" Belt, 39 inches long- - - - -	6
21300 B-2 1/2	Carriage Bolt, 3/8 x 2 1/2 inches, for attaching belt take-up and hanger to table top - - - - -	-
21371 HM-48	Table Top, 48"x 16"x 1 3/4", for American Safety Table installations- - - - -	-
21371 HM-54	Table Top, 54 inches long - - - - -	-
21371 HM-60	" " 60 inches long - - - - -	-
21371 HN-48	" " 48" x 16" x 1 3/4", for "Electro Drive" group installations - - - - -	-

LIST OF PARTS

Symbol to Order by	The figures in the last column refer only to the plates illustrating the parts and are not to be used in ordering. Refer to pink insert for prices.	Plate No.
21371 HN-54	Table Top, 54 inches long- - - - -	-
21371 HN-60	" " 60 inches long- - - - -	-
21371 HP-48	" " 48"x 16"x 1 3/4", for open line shaft installations - - - - -	-
21371 HP-54	" " 54 inches long- - - - -	-
21371 HP-60	" " 60 inches long- - - - -	-
21371 HQ	Cover Strip, wood, for oil drain - - - - -	-
21375 AP	Belt Guard, for "Electro Drive" pulley - - -	7
21660 D	Knee Press Assembly; one each Nos. 20 M, 258, 11638 F, 21661 F, 21664, 21677 A; two No. 21661 G (specify component parts in ordering)- - - - -	-
21661 F	Knee Press Lever (screw No. 69 FD, stud No. 11638 F, nut No. 258)- - - - -	6
21661 G	Knee Press Lever Connector (screw No. 95)- - -	1
21677 A	" " Rod - - - - -	6
21680 AP	Base Plate, steel- - - - -	6
21697 U	Belt Take-up and Hanger Assembly, for "Electro Drive" installations; one each Nos. 21104 B-5, 21697 V, 21697 W, 22627 A; two each Nos. 22649 K-96, 28509 B; three each Nos. 650 G-12, 652 A-20 - - - - -	7
21697 V	Belt Take-up Hanger, upper section - - - - -	-
21697 W	" " " lower section - - - - -	-
22510	Cap Screw, square head, 1/4 inch diameter, 5/8 inch long, 20 threads per inch, for transmission treadle bracket - - - - -	2
22528	Screw, for upper needle bar bearing bracket - - - - -	2
22570 A	" for hemmer mounting plate - - - - -	2
22571 B	Plug Screw, for top oiler hole - - - - -	2
22597	Spot Screw, for "V" belt pulley- - - - -	2
22627 A	Set Screw, for belt take-up hanger pivot shaft- - - - -	2
22649 K-96	Adjusting Screw, square head, 5/16 inch diameter, 1 1/2 inches long, 18 threads per inch, for belt take-up hanger (nut No. 28509 B) - - - - -	2
22757	Screw, for looper avoid shaft bracket- - - - -	2
22791 C	Screw Pin, for main shaft crank pin- - - - -	2
22799	Screw, for needle bar bearing bracket oil reservoir cover- - - - -	2
22849	Screw, for lower left side cover - - - - -	2
22863	Adjusting Screw, for feed dog holder - - - - -	2
23364 AA	Hemmer Assembly; one each Nos. 91 A, 907, 23364 AB, 23364 AC, 23364 AD, 23364 AE, 23364 AF, 23364 AG, 23425 V, 28504; two each Nos. 22593, 22711 (attaching screw No. 25 S)- - - - -	4
23364 AB	Hemmer Base- - - - -	4
23364 AC	" Scroll, right (screw No. 22711) - - -	4

LIST OF PARTS

Symbol to Order by	The figures in the last column refer only to the plates illustrating the parts and are not to be used in ordering. Refer to pink insert for prices.	Plate No.
23364 AD	Hemmer Scroll, left (stop screw No. 91 A) - -	4
23364 AE	" " Operating Rod (nut No. 907)- -	4
23364 AF	" " Slide- - - - -	4
23364 AG	" " " Spring (screw No. 22593)	1
23425 V	" Assembly Washer Plate- - - - -	4
28504	Spring, for hemmer scroll operating rod - - -	4
28509 B	Lock Nut, for belt take-up hanger adjusting screw - - - - -	2
28575	Transmission Treadle- - - - -	7
28576 B	Transmission Treadle Pitman Bracket, for "Electro Drive" installations (screw No. 22510, washer No. 28577)- - - - -	7
28577	Transmission Treadle Pitman Bracket Washer- -	2
28578 B	Transmission Treadle Base, for "Electro Drive" installations- - - - -	7
28585 B	Transmission Treadle Assembly, for "Electro Drive" installations; one each Nos. 28575, 22510, 28576 B, 28577 - - - - -	-
28602 S-23	"Electro Drive" Pulley, 2 7/8 inches working diameter, grooved for No. 2 "V" belt- - - -	3
28602 S-24	"Electro Drive" Pulley, 3 inches working diameter- - - - -	3
28602 S-25	"Electro Drive" Pulley, 3 1/8 inches working diameter- - - - -	3
28602 S-26	"Electro Drive" Pulley, 3 1/4 inches working diameter- - - - -	3
28602 S-27	"Electro Drive" Pulley, 3 3/8 inches working diameter- - - - -	3
28602 S-28	"Electro Drive" Pulley, 3 1/2 inches working diameter- - - - -	3
28602 S-29	"Electro Drive" Pulley, 3 5/8 inches working diameter- - - - -	3
29192 H	"Looper Rocker Assembly; one each Nos. 43213G, 15465 F, 51745 lapped together; also one each Nos. 258 A, 22829- - - - -	3
29470 V	Transmission Accessories Assembly, for "Electro Drive" group installations - - - -	-
29470 W	Transmission Accessories Assembly, for American Safety Table group installations	-
29477 GA	Looper Avoid Connecting Rod Assembly; one each Nos. 29126 P, 18, 269, 22747, 41255 B, 43241 D, 43246 G. Assembly is set to gauge before shipment. The approximate distance between centers is 5 13/64 inches - - - -	5
29477 GB	Feed Drive Eccentric Connecting Rod Assembly; one each Nos. 29126 S, 18, 269, 22747, 39241, 41255 B, 43241 D. Assembly is set to gauge before shipment. The approximate distance between centers is 4 9/32 inches	5

LIST OF PARTS

Symbol to Order by	The figures in the last column refer only to the plates illustrating the parts and are not to be used in ordering. Refer to pink insert for prices.	Plate No.
29477 GC	Feed Lift Eccentric Connecting Rod Assembly; one each Nos. 29126 W, 18, 269, 43235 F, 43236 A. Assembly is set to gauge before shipment. The approximate distance be- tween centers is 3 11/16 inches- - - - -	5
35755 E	Washer, for feed lift ball joint stud- - - - -	2
35780 B	Lifter Lever Extension (nut No. 258) - - - - -	5
39193	Main Oil Reservoir Sight Gauge Assembly; one each Nos. 660-92, 660-93, 666-49, 39193 A, 39193 B- - - - -	2
39193 B	Main Oil Reservoir Sight Gauge Base- - - - -	-
39221	Pulley, grooved, for "V" belt, working diameter 2 1/2 inches (spot screw No. 22597, set screw No. 22597 A)- - - - -	-
39241	Feed Drive Eccentric Connecting Rod (nut, right thread, No. 18, nut, left thread, No. 269) - - - - -	5
‡43122	Main Shaft, including crank pin (crank pin No. 39161 G, crank pin set screw No. 22791 C) - - - - -	6
43152	Needle Bar Cross Head Guide Block (screw No. 22585) - - - - -	1
43154	Needle Bar Link- - - - -	5
43164 E	Needle Bar Link Thread Eyelet, for looper thread (screw No. 87 U)- - - - -	1
43205	Feed Dog (screw No. 22596) - - - - -	1
43208 G	Looper (screw No. 73)- - - - -	1
43213 G	" Rocker- - - - -	3
‡43217	Needle Bar, includes clamp nut No. 39151 (set screw No. 88) - - - - -	5
43221	Pulley Assembly, grooved for "V" belt, work- ing diameter 2 1/2 inches; one each Nos. 39221, 43221 A; three No. 22559 A- - - - -	3
43221 A	Pulley Rim, for machines equipped with "V" belt drive (screw No. 22559 A) - - - - -	-
43227 G-3/8	Presser Foot Assembly, for 3/8 inch hem; one each Nos. 43230 K-3/8, T23, 91, 22799 B, 43230 L, 43230 M - - - - -	1
43227 G-1/2	Presser Foot Assembly, for 1/2 inch hem; one each Nos. 43230 K-1/2, T23, 91, 22799 B, 43230 L, 43230 M - - - - -	1
43228 G	Throat Plate (screw No. 28)- - - - -	1
43230 K-3/8	Presser Foot Bottom, for 3/8 inch hem (hinge screw No. 22799 B) - - - - -	1
43230 K-1/2	Presser Foot Bottom, for 1/2 inch hem (hinge screw No. 22799 B) - - - - -	1
43230 L	Presser Foot Shank - - - - -	1
43230 M	Presser Foot Spring (screw No. T23)- - - - -	1
‡43234 G	Feed Bar, including tiltable feed dog holder No. 51134 G (set screw No. 89, feed dog holder adjusting screw No. 22863)- - - - -	5

LIST OF PARTS

Symbol to Order by	The figures in the last column refer only to the plates illustrating the parts and are not to be used in ordering. Refer to pink insert for prices.	Plate No.
43234 N	Feed Bar Guiding Stud (nut No. 907, lock washer No. 652 C-9) - - - - -	2
43234 U	Feed Bar Guiding Stud Fork (screw No. 906)- - - - -	3
43236 A	Feed Lift Eccentric Connecting Rod- - - - -	5
43240	Feed Rocker - - - - -	3
43240 U	" " Shaft Bushing - - - - -	1
43242 A	Looper Drive Shaft Arm, front (clamp stud No. 43242 J, nut No. 51246, washer No. 6042 A)	4
43242 B	Looper Drive Shaft Arm Ball Joint (bearing screws No. 97 A, stud washer No. 15488) - - - - -	1
43242 H	Looper Drive Shaft Arm, rear- - - - -	5
43242 N	" Connecting Rod (nut, right thread, No. 15037 A, nut, left thread, No. 43242P)	2
43242 P	" Connecting Rod Nut, left thread- - - - -	2
43243 N	" Drive Shaft Bushing- - - - -	1
43245 A	" Avoid Shaft- - - - -	3
43245 D	" Avoid Shaft Collar (set screw No. 88, spot screw No. 22764)- - - - -	4
43245 H	" Avoid Adjusting Arm (clamp screw No. 820) - - - - -	5
43245 J	" Avoid Shaft Bracket (screw No. 22757, dowel pin No. 43245 K- - - - -	3
43245 K	" Avoid Shaft Bracket Dowel Pin- - - - -	2
43246 G	" Avoid Eccentric Connecting Rod (nut, right thread No. 18, nut, left thread No. 269) - - - - -	5
43253	Needle Bar Bushing, lower (screw No. 22707)	5
43253 G	" " Bearing Bracket, includes bushing No. 12873 A (screw No. 22528)- - - - -	3
43253 N	" " Bearing Bracket Oil Reservoir Cover (screw No. 22799)- - - - -	2
43253 U-4	Shim, .004 inch thick, for needle bar bearing bracket - - - - -	2
43253 U-5	" .005 inch thick - - - - -	2
43253 U-6	" .006 inch thick - - - - -	2
43253 U-7	" .007 inch thick - - - - -	2
43253 U-8	" .008 inch thick - - - - -	2
43253 U-9	" .009 inch thick - - - - -	2
43255 B	Lifter Lever- - - - -	3
43255 G	Needle Thread Tension Disc Separator (screw No. 94) - - - - -	3
43255 N	Lifter Chain Guide Bracket, for guiding chain around the "Electro Drive" on "Electro Drive" installations- - - - -	4
43257 A	Presser Spring Regulator- - - - -	5
43257 H	" " Plunger- - - - -	5
43257 N	" " " Cap (screw No. 22585)	2
43257 U	" " " Bearing- - - - -	1
43261 A	Needle Bar Cover (hinge pin No. 43261 D)- - - - -	6

LIST OF PARTS

Symbol to Order by	The figures in the last column refer only to the plates illustrating the parts and are not to be used in ordering. Refer to pink insert for prices.	Plate No.
43262 J	Side Cover, left (attaching screw No. 22848, porcelain insert No. 668-1, porcelain in- sert ferrule No. 668-14)- - - - -	7
43262 N	Main Oil Reservoir Assembly (sight gauge No. 39193, oil cup No. 666-11)- - - - -	6
43264 G	Looper Thread Tube (screw, lower, No. 98 A, screw, upper, No. 376)- - - - -	4
43265 A	Main Oil Reservoir Cover and Lead-in Thread Eyelet (attaching screw No. 222 D, oil cup No. 666-50, porcelain insert No. 668-1, porcelain insert ferrule No. 668-14)- - - -	4
43280 B	Throat Plate Support (screw No. 376)- - - - -	4
43281 N	Rear Cover (screw No. 25 CC)- - - - -	6
43282 A	Hemmer Mounting Plate (screw No. 22570 A) - -	3
43283 A	Side Cover, lower, left (screw No. 22849) - -	6
43283 B	" " Gasket- - - - -	3
43294 F	Oil Drain - - - - -	6
43457 B	Presser Spring- - - - -	1
51134 G	Feed Dog Holder, tiltable (nut No. 258 A, washer No. 6042 A)- - - - -	1
51292 F-2	Tension Spring, for looper threads- - - - -	1





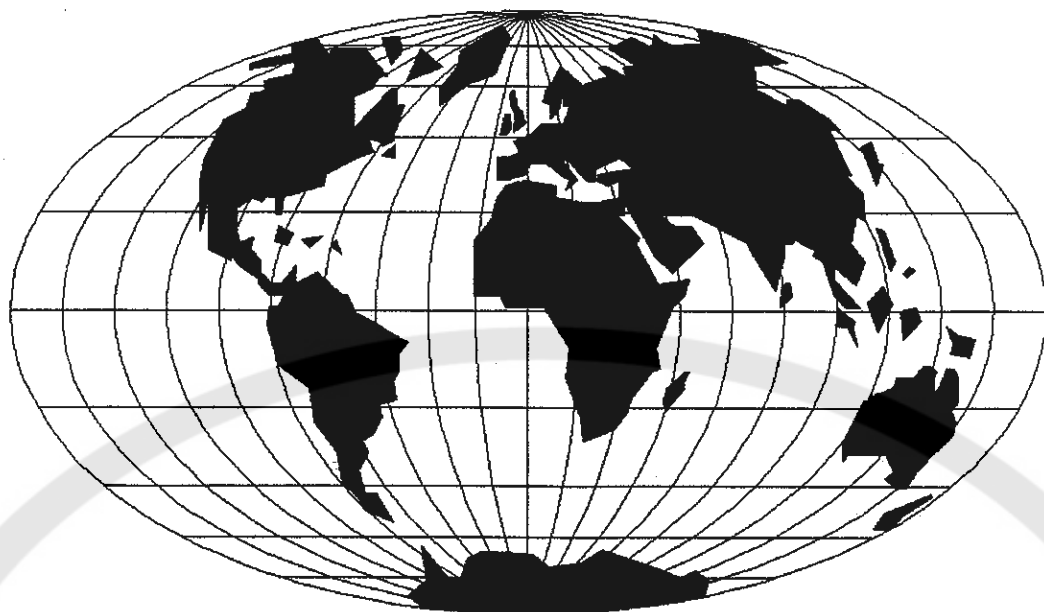

## WORLDWIDE SALES AND SERVICE

Union Special Corporation maintains sales and service facilities throughout the world. These offices will aid you in the selection of the right sewing equipment for your particular operation. Union Special Corporation representatives and service technicians are factory trained and are able to serve your needs promptly and efficiently. Whatever your location, there is a qualified representative to serve you.

---

Brussels, Belgium  
Charlotte, N.C.  
El Paso, TX  
Hong Kong, China  
Huntley, IL  
Leicester, England  
Lille, France  
Miami, FL  
Milan, Italy  
Möglingen, Germany  
Montreal, Quebec  
Osaka, Japan  
Santa Fe Springs, CA

Other Representatives throughout  
all parts of the world.



*Union Special*  
INDUSTRIAL SEWING EQUIPMENT