

**FIRST  
EDITION**



*Union Special*  
INDUSTRIAL SEWING EQUIPMENT

**CATALOG NO. 103AU**

---

---

**STYLE**

**39500AU**

---

---

**39500 CLASS**

**STREAMLINED**

**HIGH SPEED OVERSEAMERS**

Catalog No. 103 AU  
(Supplement to Catalog No. 103 N)

INSTRUCTIONS  
FOR  
ADJUSTING AND OPERATING

LIST OF PARTS

CLASS 39500

Style  
39500 AU

The parts listed in this catalog are  
furnished at list prices for repairs only.

First Edition

Copyright 1964  
by  
Union Special Machine Co.  
Rights Reserved in All Countries

*Union Special*  
**MACHINE COMPANY**  
INDUSTRIAL SEWING MACHINES  
**CHICAGO**

Printed in U.S.A.

## IDENTIFICATION OF MACHINE

Each Union Special machine is identified by a Style number which is stamped into the name plate on the machine. Style numbers are classified as standard and special. Standard Style numbers have one or more letters suffixed, but never contain the letter "Z". Example: "Style 39500 AU". Special Style numbers contain the letter "Z". When only minor changes are made in a standard machine, a "Z" is suffixed to the standard Style number. Example: "Style 39500 AUZ".

Styles of machines similar in construction are grouped under a class number which differs from the style number, in that it contains no letters. Example: "39500".

## APPLICATION OF CATALOG

This catalog is a supplement to Catalog No. 103 N and should be used in conjunction therewith. Only those parts which are used on Style 39500 AU, and not on Style 39500 L, are illustrated and listed at the back of the book.

This catalog applies specifically to the Standard Style of machine as listed herein. It can also be applied with discretion to some Special Styles of machines in this class. Reference to direction, such as right, left, front, back, etc., are given from the operator's position while seated at the machine. Operating direction of handwheel is away from the operator.

## STYLE OF MACHINE

Single Curved Blade Needle, Two Loper, Three Thread, High Throw, Overseaming Machine. Plain Feed, Trimming Mechanism With Spring Pressed Lower Knife. Automatic Lubricating System.

39500 AU Plain feed machine, for attaching zippers with sliders and staples already in place (and overedge the facings) to pants flies, skirts, jackets and similar garments. Three thread machine. Seam specification 504-SSa-1, standard seam width 3/16 inch; stitch range 4 to 10 per inch; cam adjusted feed.

## OILING

**CAUTION!** Oil was drained from machine when shipped, so reservoir must be filled before beginning to operate. Oil capacity of Class 39500 is six ounces. A straight mineral oil of a Saybolt viscosity of 200 to 250 seconds at 100° Fahrenheit should be used.

Machine is filled with oil at spring cap in top cover. Oil level is checked at sight gauge on front of machine. Red bulb on oil level indicator should show between gauge lines.

Machine is automatically lubricated. No oiling is necessary, other than keeping the main reservoir filled. Check oil daily, before the morning start; add oil as required.

Drain plug screw is located at the back of the machine near bottom edge of base. It is a magnetic screw designed to accumulate possible foreign materials which may have entered the crankcase. It should be removed and cleaned periodically.

## IDENTIFYING PARTS

Where the construction permits, each part is stamped with its part number. On some of the smaller parts, and on those where construction does not permit, an identification letter is stamped in to distinguish the part from similar ones.

Part numbers represent the same part, regardless of the catalog in which they appear.

**IMPORTANT! ON ALL ORDERS, PLEASE INCLUDE PART NAME AND THE STYLE OF MACHINE FOR WHICH PART IS ORDERED.**

## TERMS

Prices are net cash and subject to change without notice. All shipments are forwarded f. o. b. shipping point. Parcel Post shipments are insured unless otherwise directed. A charge is made to cover postage and insurance.

## NEEDLES

Each Union Special needle has both a type number and a size number. The type number denotes the kind of shank, point, length, groove, finish and other details. The size number, stamped on the needle shank, denotes the largest diameter of blade, measured in thousandths of an inch, midway between the shank and the eye. Collectively, the type number and the size number is the complete symbol.

Style 39500 AU uses a curved blade needle. The standard needle for this Style is Type 154 GAS. It has a round shank, round point, curved blade, is standard length, single groove, struck groove, spotted, chromium plated and is available in sizes 022, 025, 027, 029, 032, 036, 040, 044, 049, 054.

To have needle orders promptly and accurately filled, an empty package, a sample needle, or the type and size number should be forwarded. Use description on label. A complete order would read: "1000 Needles, Type 154 GAS, Size 032".

Selection of the proper needle size should be determined by size of thread used. The thread should pass freely through the needle eye in order to produce a good stitch formation.

## USE GENUINE NEEDLES AND REPAIR PARTS

Success in the operation of these machines can be secured only with genuine Union Special Needles and Repair Parts as furnished by the Union Special Machine Company, its subsidiaries and authorized distributors. They are designed according to the most approved scientific principles, and are made with utmost precision. Maximum efficiency and durability are assured.

Genuine needles are packaged with labels marked *Union Special*. Genuine repair parts are stamped with the Union Special trademark. Each trademark is your guarantee of the highest quality in materials and workmanship.

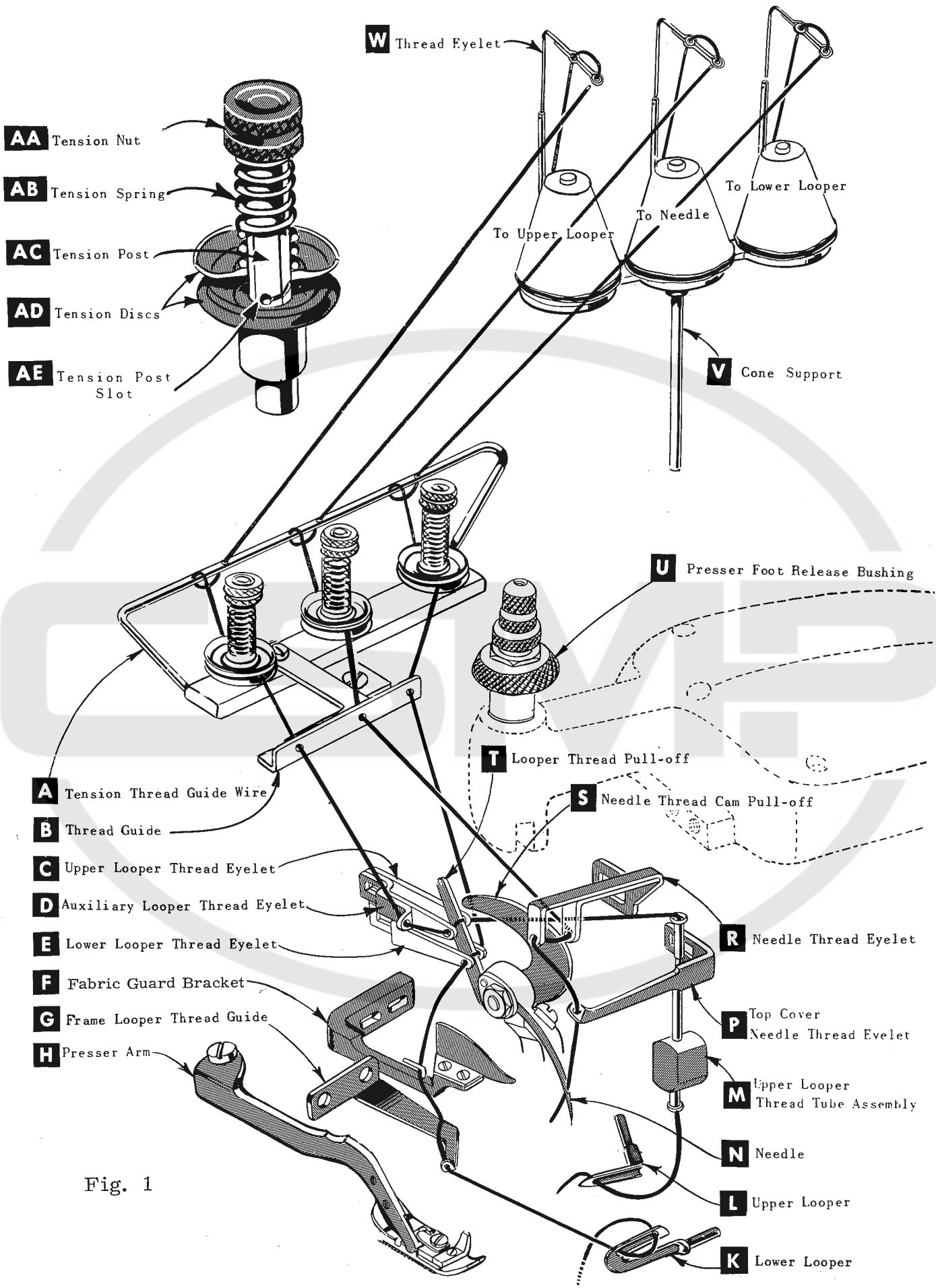

**AA** Tension Nut

**AB** Tension Spring

**AC** Tension Post

**AD** Tension Discs

**AE** Tension Post Slot

**W** Thread Eyelet

To Upper Looper

To Needle

To Lower Looper

**V** Cone Support

**U** Presser Foot Release Bushing

**T** Looper Thread Pull-off

**S** Needle Thread Cam Pull-off

**A** Tension Thread Guide Wire

**B** Thread Guide

**C** Upper Looper Thread Eyelet

**D** Auxiliary Looper Thread Eyelet

**E** Lower Looper Thread Eyelet

**F** Fabric Guard Bracket

**G** Frame Looper Thread Guide

**H** Presser Arm

**R** Needle Thread Eyelet

**P** Top Cover Needle Thread Eyelet

**M** Upper Looper Thread Tube Assembly

**N** Needle

**L** Upper Looper

**K** Lower Looper

Fig. 1

## CHANGING NEEDLES, Etc. (Pages 6 and 10)

All instructions with regards to Changing Needles, Presser Foot Pressure, Feed Eccentrics, Thread Stand, Threading, etc., are the same as those for Style 39500 L covered by Catalog No. 103 N with the following exceptions. The differences, applicable only to Style 39500 AU, are underlined with page numbers where each is found in Catalog No. 103 N.

### FEED ECCENTRICS (Page 6)

The feed eccentric used in this machine has been selected to produce approximately 7 stitches per inch. It will be noted that the part number of the feed eccentric is 39540-7. Minor numbers of the part symbol indicate approximate number of stitches obtainable when using that eccentric. Unless otherwise specified, machine will be shipped with above eccentric.

The following stitch number feed eccentrics are available under No. 39540. 4, 5, 6, 7, 8, 9, 10, 11, 12, 13, 14, 15, 16, 18, 20, 22, 24, 26, 28, 30, 32, 34, 36 and 40. Only one eccentric is supplied with each machine. Additional eccentrics may be ordered separately. To order an eccentric, use number 39540 with a minor number suffixed to indicate number of stitches desired. Example: "39540-8".

### THREAD STAND (Page 10)

After thread comes from the cone on thread stand (V, Fig. 1), it is brought up through the back thread eyelet, then down through front thread eyelet (W). Next it is threaded through each pair of holes in tension thread guide wire (A), down right hand hole and up through left hand hole. Then thread continues between tension discs (AD), through slot (AE), and on through thread guide (B).

### THREADING (Page 10)

Only parts involved in threading are shown in threading diagram (Fig. 1). Parts are placed in their relative positions for clarity.

It will simplify threading this machine to follow the recommended sequence of threading lower looper first, upper looper second and needle third.

Before beginning to thread, swing cloth plate open, turn handwheel in operating direction until needle (N) is at high position, release pressure on presser foot by turning presser foot release bushing (U); and swing presser arm (H) out of position.

Be sure threads, as they come from the tension thread guide, are between the tension discs (AD) and in diagonal slots (AE) in tension posts (AC).

### TO THREAD LOWER LOOPER (Page 10)

Double end of thread and lead it through both eyes of the lower looper thread eyelet (E, Fig. 1) from right to left. NOTE: Thread must pass in front of looper thread pull-off (T). Lead thread behind fabric guard (F) and through hole of frame looper thread guide (G). Turn handwheel in operating direction until heel of lower looper (K) is all the way to the left; then thread through both eyes from left to right. The left eye of the lower looper can be threaded easily if tweezers are in left hand.

## TO THREAD UPPER LOOPER (Page 10)

Turn the handwheel until the point of the upper looper (L) is all the way left. Lead thread through the auxiliary looper thread eyelet (D) from back to front, then through both eyes of the upper looper thread eyelet (C) from left to right. NOTE: Thread must pass in front of the looper thread pull-off (T). After pulling up the upper looper thread tube assembly (M), lead the thread under the neck of top cover casting and down through the thread tube assembly. Pull the thread out bottom of tube: push the tube down, then insert the thread through the upper looper eye from front to back.

**CAUTION!** Be sure the upper looper thread is under the lower looper thread when passing from tube assembly to upper looper eye.

## TO THREAD THE NEEDLE (Page 10)

Turn the handwheel in operating direction until the needle (N, Fig. 1) is at its highest position. Insert the needle thread from right to left, through both eyes of the needle thread eyelet (R), under the neck of the top cover casting; then down through the hole in the top cover needle thread eyelet (P). Thread the needle from the front.

## THREAD TENSION (Page 10)

The amount of tension on the needle and looper threads is regulated by three knurled tension nuts (AA, Fig. 1). Tension on the threads should be only enough to secure proper stitch formation.

## ASSEMBLING AND ADJUSTING SEWING PARTS (Pages 11 thru 17)

All instructions pertaining to the adjustment of Style 39500 AU are the same as those for Style 39500 L covered by Catalog No. 103 N with the following exceptions. The differences, applicable only to Style 39500 AU, are underlined on the following pages with page numbers where each is found in Catalog No. 103 N.

## SETTING THE NEEDLE (Page 11)

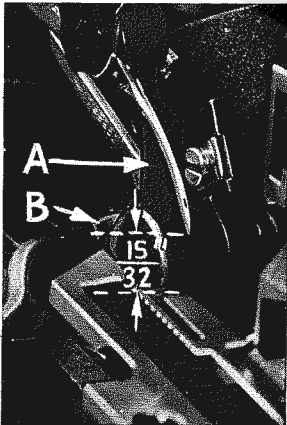

With the throat plate in position, needle should center in the front end of needle slot. When needle is at high position, the needle point should be set 15/32 inch above throat plate (Fig. 3). Move the needle driving arm (A, Fig. 3) by loosening the clamp screw (B). Remove throat plate.

At this point, insert lower looper (A, Fig. 5) into bar (B). With lower looper at left end of its stroke, set looper point 1/8 inch from the center of the needle (Fig. 5), using looper gauge No. 21225-1/8. Do not have lower looper deflecting the needle. Tighten nut (C).

Fig. 3

Now assemble main (front) feed dog (E, Fig. 4).

## SETTING THE UPPER LOOPER (Page 13)

Insert the upper looper (A, Fig. 7A) in its holder. Screw (B) holds upper looper in its holder, and permits it to be pushed in or out or turned around its shank. Insert upper looper holder into upper looper shaft, if it is not already in place. Screw (C) on clamp holds the upper looper holder in the shaft. Locate the upper looper in its holder so that the shank extends  $1/16$  to  $3/32$  inch beyond holder (Fig. 7A).

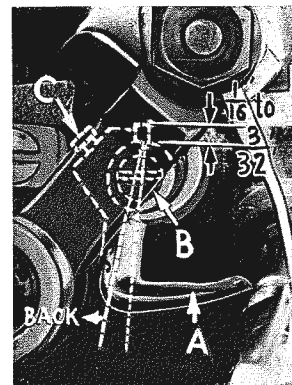

Fig. 7A

When the upper looper is at the right end of its stroke, upper looper holder should be set to position upper looper shank back of vertical (Fig. 7A), but be sure there is a clearance between heel of looper and casting. Now, by adjusting looper holder in or out of upper looper shaft and by turning the looper around its shank, set upper looper point to cross lower looper to the left of the lower looper eye with .002 to .004 inch clearance (Fig. 8A).

Next, turn handwheel until upper looper is at left end of its travel. Check  $5/32$  inch dimension of upper looper point with respect to center line of needle and  $29/64$  inch dimension of upper looper point with respect to top of throat plate (Fig. 9A). The  $29/64$  inch dimension is increased by turning upper looper holder counterclockwise, looking from left end of machine. If the  $5/32$  inch dimension is too small, pull the upper looper holder out of the upper looper shaft to correct the condition. Turn upper looper holder forward (counterclockwise, looking from left end of machine) so that the upper looper point crosses the lower looper, without interference, as close as possible to the left of lower looper eye. It may be necessary to rotate the upper looper around its shank slightly to maintain conditions shown (Fig. 8A).

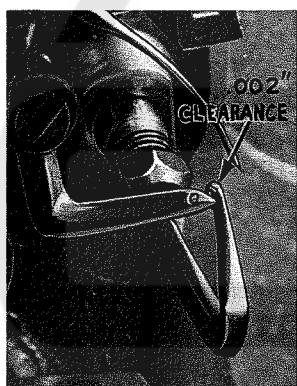

Fig. 8A

If the  $5/32$  inch dimension is too large, push upper looper holder into upper looper shaft to correct the condition. Turn upper looper holder backward, if necessary, so that the upper looper point crosses the lower looper, without interference, as close as possible to the left of the lower looper eye. It may be necessary to rotate the upper looper around its shank slightly to maintain conditions shown (Fig. 8A).

When the correct setting is obtained, it can be checked quickly as follows: As the upper looper is moving to the right, when the upper looper eye centers on the needle, the bottom of the needle eye should be about level with the top surface of the looper.

Check the setting to avoid interference between the upper looper and the needle on the needle downstroke. If the needle rubs the back of the upper looper, pull the looper out of its holder slightly to reduce the  $1/16$  to  $3/32$  inch dimension (Fig. 7A) and rotate the looper a short distance counterclockwise, looking from the left end of the machine. Reset to maintain the dimensions of Figures 8A and 9A.

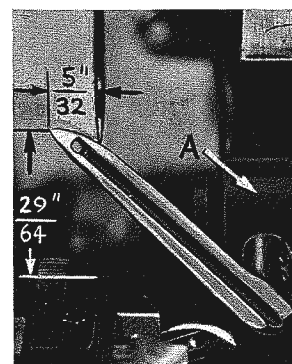

Fig. 9A



## STARTING TO OPERATE (Page 17)

Be sure machine is threaded according to threading diagram (Fig. 1, page 5). With thread tensions light, set looper thread eyelets (C, E) about horizontal and in the middle of their front to back locations. Operate machine slowly, without presser foot in place, to make sure that chain forms and moves off the tongue freely. Swing presser foot into position, insert material and sew slowly.

## NEEDLE THREAD CONTROL (Page 17)

While sewing on material, check needle thread control as follows: Usually all the needle thread is drawn on needle down stroke. At top of needle stroke, thread should be just tight enough to feed chain off the stitch tongue. Stitch tends to pull down slightly if excessive thread is pulled on the up stroke. With needle at bottom of stroke, position needle thread eyelet (R, Fig. 1) so that needle thread cam pull-off (S) just contacts needle thread.

## LOWER LOOPER THREAD CONTROL (Page 17)

With material under presser foot, set lower looper thread eyelet (E, Fig. 1) back far enough so thread is a little slack when looper thread pull-off (T) reaches its most rearward position. Looper thread pull-off is set about 1/8 inch behind needle thread cam pull-off (S). Frame looper thread guide (G) should be set with its left hand eyelet approximately 1/8 inch right of lower looper (K) heel eyelet at the time lower looper is at extreme left end of its travel.

While sewing on material, check drawing off of the looper thread as follows: A portion of the lower looper thread should be drawn through the tension before lower looper thread comes off upper looper. To increase amount of thread drawn through the tension while lower looper thread is on upper looper, move lower looper thread eyelet (E) down, keeping the same amount of pull-off action.

## UPPER LOOPER THREAD CONTROL (Page 17)

Before proceeding to adjust upper looper thread eyelet (C, Fig. 1) balance all three tensions to give a normal appearing stitch. Moderate change in these tensions will not markedly affect the purl.

During needle down stroke, the forward stroke of looper thread pull-off (T) will draw upper looper thread through the tension. When normal amount of looper thread is drawn, upper looper thread will have almost all slack taken up as looper thread pull-off reaches its most rearward position.

## POSITIONING THE PURL

To move the purl more under the edge, both looper thread eyelets (C, E, Fig. 1) should be raised, keeping the same amount of pull-off. Usually it is better to have slightly more pull-off on upper thread than on lower thread.

If it becomes necessary to move looper thread pull-off (T), be sure to take up all end play in needle drive shaft before tightening. If upper looper is located so that it is higher over throat plate than recommended in Fig. 10, the purl will tend to form near top edge. If upper looper is too low, the purl will form nearer bottom edge.

## THREAD TENSIONS

The needle thread tension required is a function of needle thread and material being sewn. In general, lower looper thread tension should be set as high as possible without causing needle thread to be pulled down. Upper looper thread tension should be increased as long as the elasticity of the chain increases, or until the purl is pulled too far over the top.

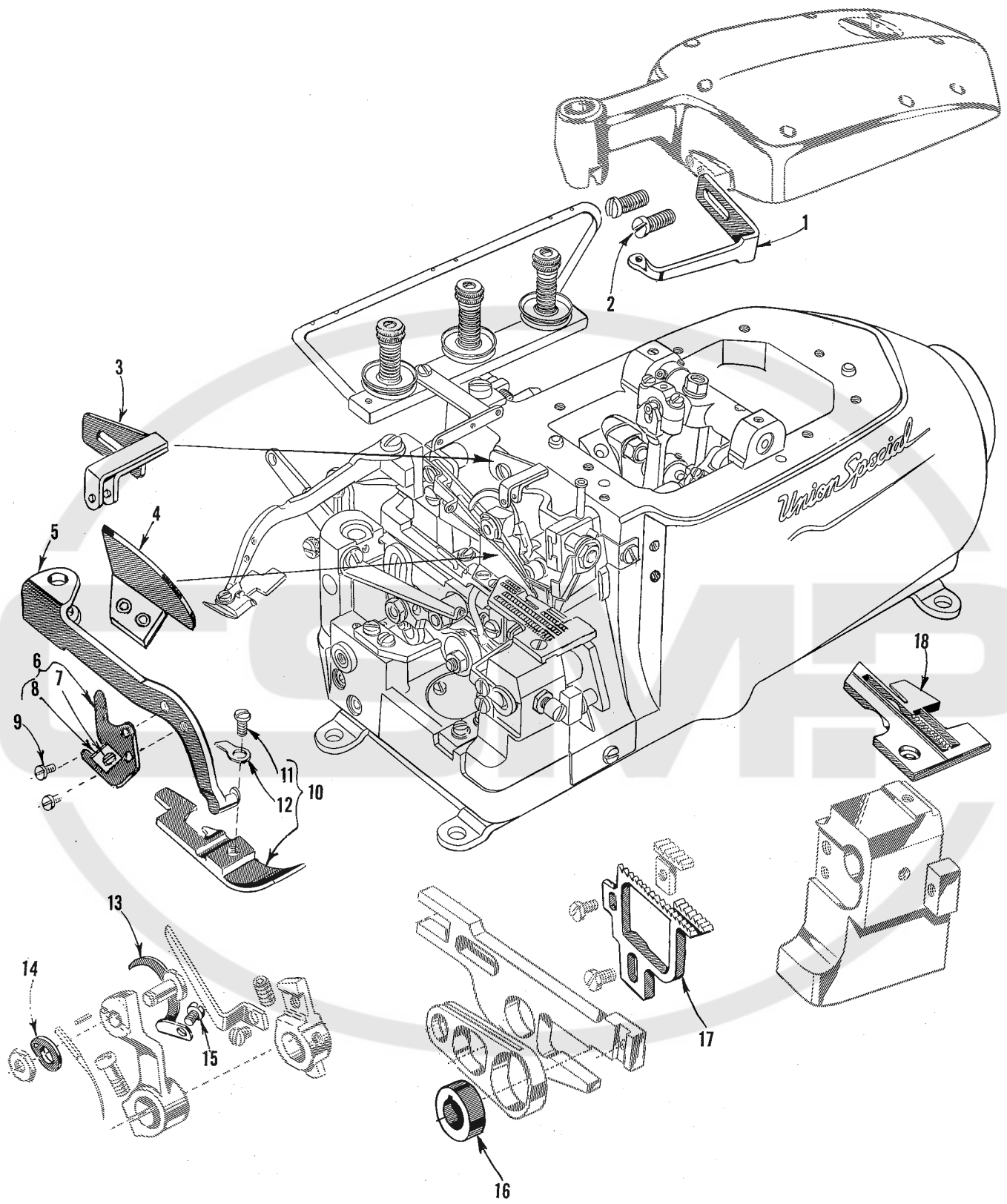

The parts illustrated on the preceding page and described on this page represent the parts that are used on Style 39500 AU, but are not used on Style 39500 L.

Those parts shown in phantom views, and bearing no reference numbers, are common to Styles 39500 AU and 39500 L.

Use Catalog No. 103 N for all parts not illustrated or described here.

<u>Ref. No.</u>	<u>Part No.</u>	<u>Description</u>	<u>Amt. Req.</u>
1	39563 F	Top Cover Needle Thread Eyelet -----	1
2	22569 B	Screw - Top Cover Needle Thread Eyelet-----	2
3	39563 H	Needle Thread Eyelet -----	1
4	39578 M	Fabric Guard-----	1
5	39556 AU	Presser Arm-----	1
6	39556 M	Chain Cutting Knife -----	1
7	22798	Screw-Chain Cutting Knife -----	1
8	39556 L	Chain Cutting Knife -----	1
9	605	Screw - Chain Cutting Knife-----	2
10	39520 AU	Presser Foot-----	1
11	22768 B	Screw - Hinge Spring -----	1
12	39530 G	Presser Foot Hinge Spring-----	1
13	39563 G	Needle Thread Cam Pull-off -----	1
14	39551 A	Needle Clamp Washer -----	1
15	77 A	Screw - Needle Thread Cam Pull-off - -----	1
16	39540 B-7	Feed Driving Eccentric, .064 inch throw -----	1
17	39505 AU	Feed Dog -----	1
18	39524 AU	Throat Plate, marked "BG"-----	1

NOTE: Use No. 51292 F-8 tension spring for the needle thread and (2) No. 51292 F-4 tension springs for the two looper threads.

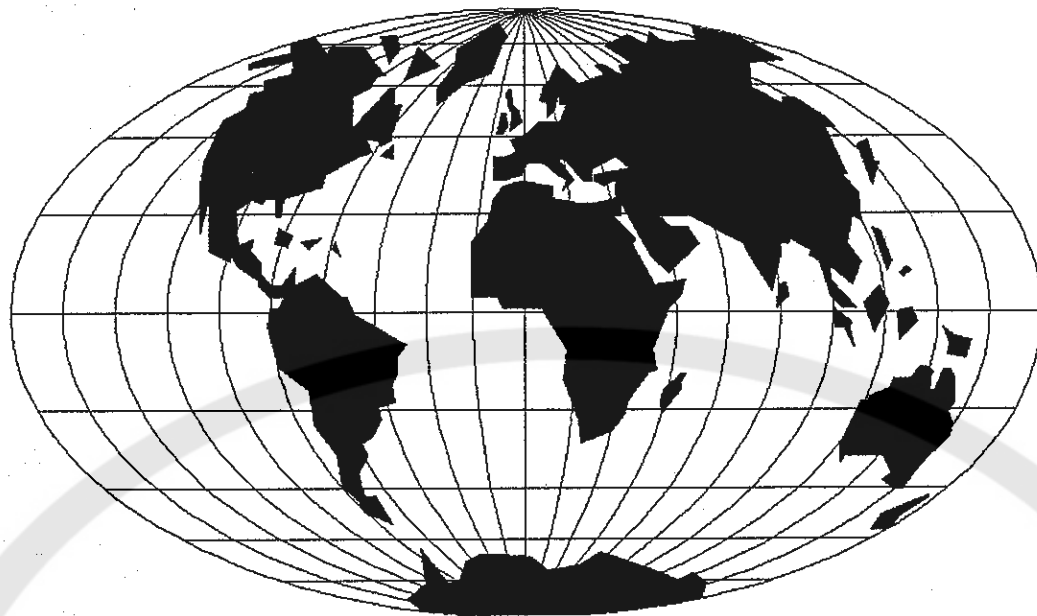

## WORLDWIDE SALES AND SERVICE

Union Special Corporation maintains sales and service facilities throughout the world. These offices will aid you in the selection of the right sewing equipment for your particular operation. Union Special Corporation representatives and service technicians are factory trained and are able to serve your needs promptly and efficiently. Whatever your location, there is a qualified representative to serve you.

---

Brussels, Belgium  
Charlotte, N.C.  
El Paso, TX  
Hong Kong, China  
Huntley, IL  
Leicester, England  
Lille, France  
Miami, FL  
Milan, Italy  
Mögingen, Germany  
Montreal, Quebec  
Osaka, Japan  
Santa Fe Springs, CA

Other Representatives throughout  
all parts of the world.



*Union Special*  
INDUSTRIAL SEWING EQUIPMENT