

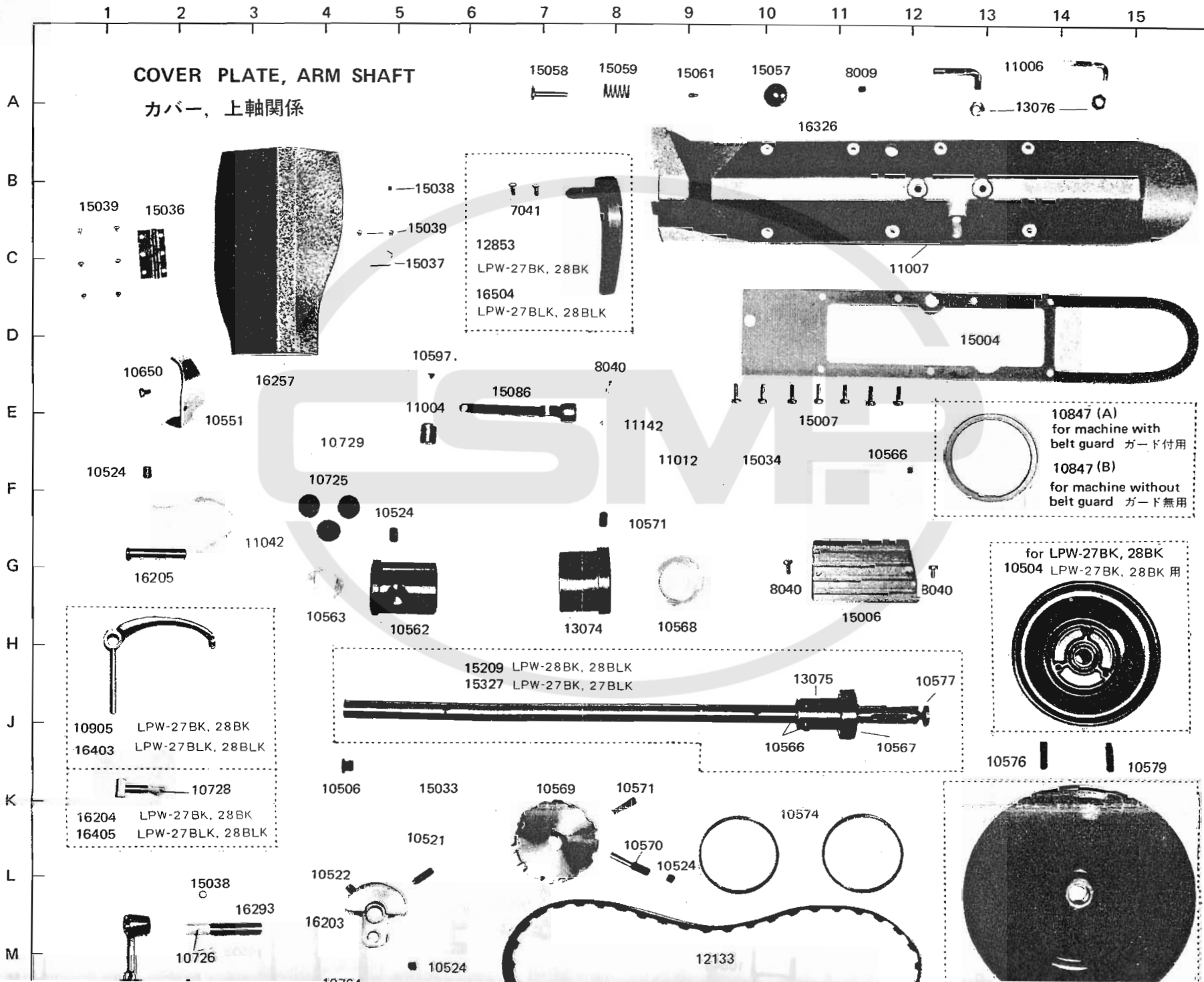

# SEIKO LPW

## PARTS LIST

MODEL: LPW-27BK, 28BK, 27BLK, 28BLK,



COVER PLATE, ARM SHAFT

カバー, 上軸関係

15058



15059



15061



15057



8009



11006



11006



13076



13076



16326

15039



15036



15038



15039



12853



LPW-27BK, 28BK

16504



LPW-27BLK, 28BLK

7041

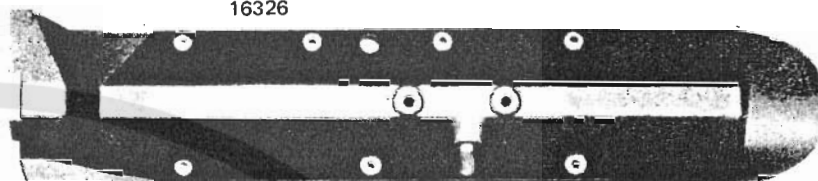

11007

15004



10650



16257



10597



8040



15086



11142



15007



10847 (A)

for machine with belt guard ガード付用

10847 (B)

for machine without belt guard ガード無用



10524



10729



11012



15034



10566



F

10725



10571



11042



G

16205



10524



8040



8040



8040



for LPW-27BK, 28BK  
10504 LPW-27BK, 28BK 用

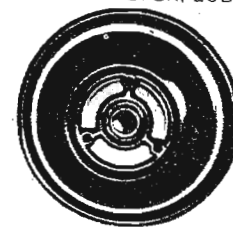

H

10563



10562



13074



10568



15006



J

10905



LPW-27BK, 28BK

16403



LPW-27BLK, 28BLK

15209 LPW-28BK, 28BLK

15327 LPW-27BK, 27BLK

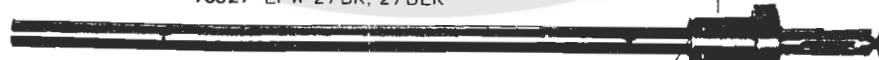

13075



10577



10566



10567



10576



10579



K

16204



LPW-27BK, 28BK

16405



LPW-27BLK, 28BLK

15038



10522



16203



10521



10569



10571



10570



10524



10574



L



10726



M

10704



10524



12133



# COVER PLATE, ARM SHAFT

カバー、上軸関係

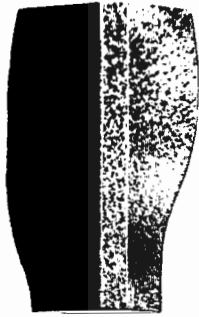
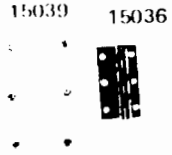

15038  
15039  
15037

7041

12853  
LPW-27BK, 28BK  
16504  
LPW-27BLK, 28BLK



16257

10597

8040

15086

11004

11142



15007

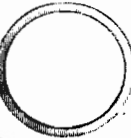

10847 (A)  
for machine with  
belt guard ガード付用  
10847 (B)  
for machine without  
belt guard ガード無用

10524

10729

10725

10524

10571

11012

15034

10566

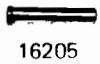

16205

11042

10524

10571

10568

8040

15006

for LPW-27BK, 28BK  
10504 LPW-27BK, 28BK 用

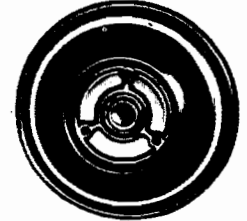

10905 LPW-27BK, 28BK  
16403 LPW-27BLK, 28BLK

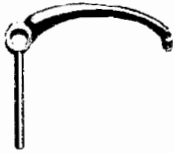

10563

10562

13074

10568

8040

8040

15209 LPW-28BK, 28BLK  
15327 LPW-27BK, 27BLK

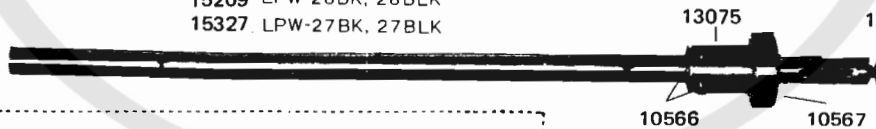

13075

10577

10566

10567

10576

10579

16204 LPW-27BK, 28BK  
16405 LPW-27BLK, 28BLK

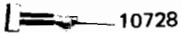

10728

10506

15033

10569

10571

10574

16204 LPW-27BK, 28BK  
16405 LPW-27BLK, 28BLK

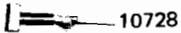

10728

10506

15033

10569

10571

10574

10521

10570

10524

16204 LPW-27BK, 28BK  
16405 LPW-27BLK, 28BLK

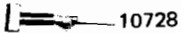

10728

10506

15033

10569

10571

10574

10522

10570

10524

16204 LPW-27BK, 28BK  
16405 LPW-27BLK, 28BLK

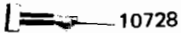

10728

10506

15033

10569

10571

10574

16203

10524

10764

12133

16204 LPW-27BK, 28BK  
16405 LPW-27BLK, 28BLK

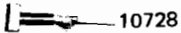

10728

10506

15033

10569

10571

10574

16203

10524

10764

12133

16204 LPW-27BK, 28BK  
16405 LPW-27BLK, 28BLK

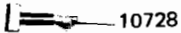

10728

10506

15033

10569

10571

10574

16203

10524

10764

12133

16204 LPW-27BK, 28BK  
16405 LPW-27BLK, 28BLK

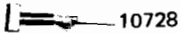

10728

10506

15033

10569

10571

10574

16203

10524

10764

12133

16204 LPW-27BK, 28BK  
16405 LPW-27BLK, 28BLK

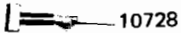

10728

10506

15033

10569

10571

10574

16203

10524

10764

12133

16204 LPW-27BK, 28BK  
16405 LPW-27BLK, 28BLK

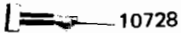

10728

10506

15033

10569

10571

10574

16203

10524

10764

12133

16204 LPW-27BK, 28BK  
16405 LPW-27BLK, 28BLK

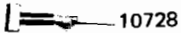

10728

10506

15033

10569

10571

10574

16203

10524

10764

12133

16204 LPW-27BK, 28BK  
16405 LPW-27BLK, 28BLK

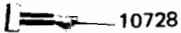

10728

10506

15033

10569

10571

10574

16203

10524

10764

12133

16204 LPW-27BK, 28BK  
16405 LPW-27BLK, 28BLK

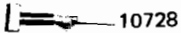

10728

10506

15033

10569

10571

10574

16203

10524

10764

12133

16204 LPW-27BK, 28BK  
16405 LPW-27BLK, 28BLK

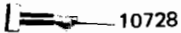

10728

10506

15033

10569

10571

10574

16203

10524

10764

12133

16204 LPW-27BK, 28BK  
16405 LPW-27BLK, 28BLK

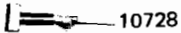

10728

10506

15033

10569

10571

10574

16203

10524

10764

12133

16204 LPW-27BK, 28BK  
16405 LPW-27BLK, 28BLK

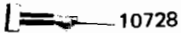

10728

10506

15033

10569

10571

10574

16203

10524

10764

12133

16204 LPW-27BK, 28BK  
16405 LPW-27BLK, 28BLK

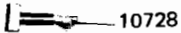

10728

10506

15033

10569

10571

10574

16203

10524

10764

12133

16204 LPW-27BK, 28BK  
16405 LPW-27BLK, 28BLK

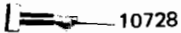

10728

10506

15033

10569

10571

10574

16203

10524

10764

12133

16204 LPW-27BK, 28BK  
16405 LPW-27BLK, 28BLK

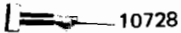

10728

10506

15033

10569

10571

10574

16203

10524

10764

12133

16204 LPW-27BK, 28BK  
16405 LPW-27BLK, 28BLK

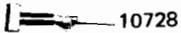

10728

10506

15033

10569

10571

10574

16203

# THREAD GUIDE, TENSION, CHANGE OVER MECHANISM

切り換え、糸掛、調子板関係

O  
P  
Q  
R  
S  
T  
U

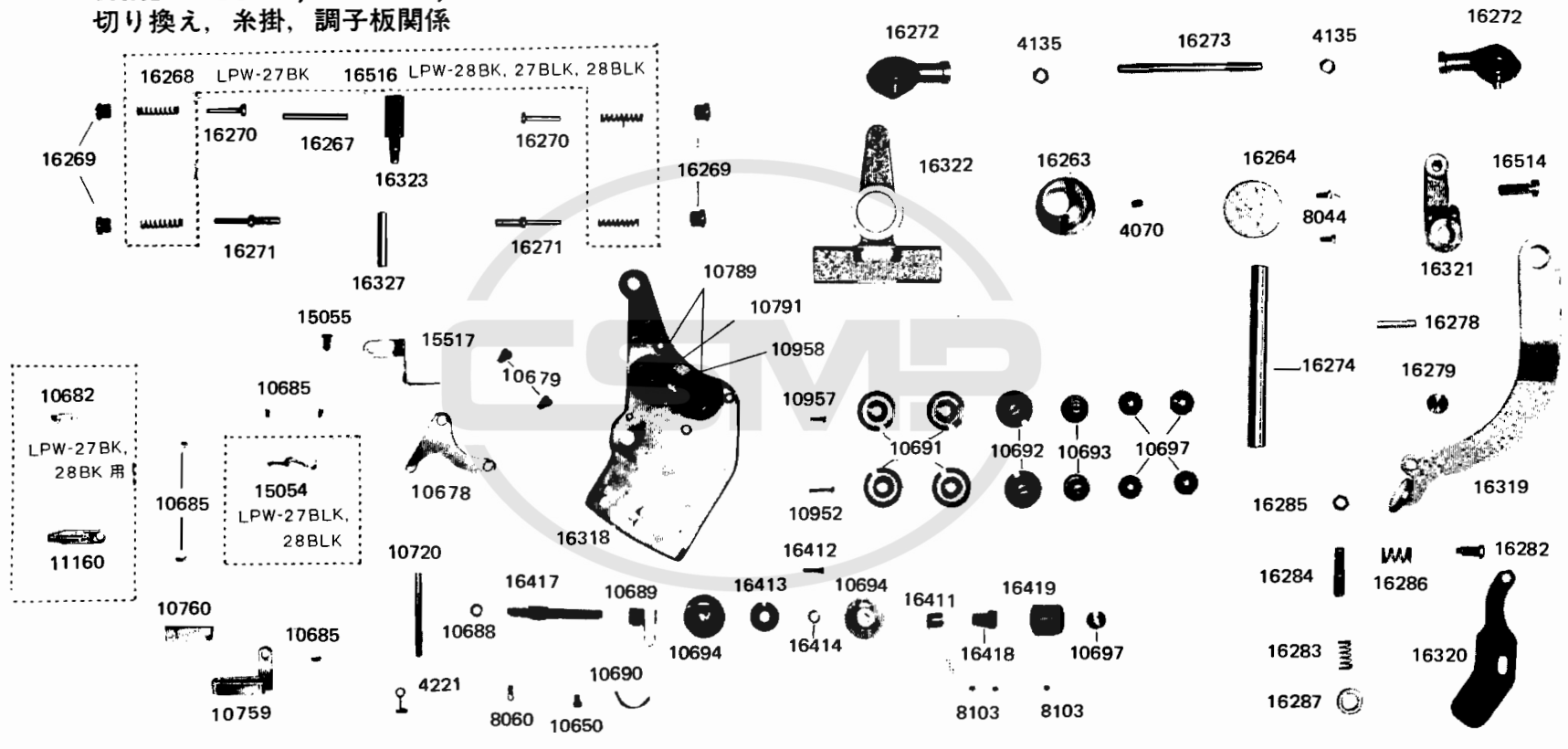

SEIKO SEWING MACHINE CO., LTD.

TOKYO·JAPAN

Telex: 2657148 SEIKO J.

LPW-27BK, 28BK, 27BLK, 28BLK

1 2 3 4 5 6 7 8 9 10 11 12 13 14 15

NEEDLE BAR MECHANISM

針棒関係

A  
B  
C  
D  
E  
F  
G

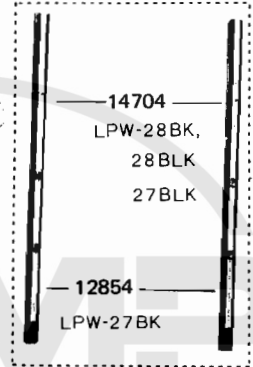
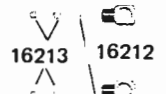
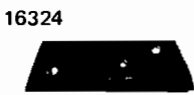

16215

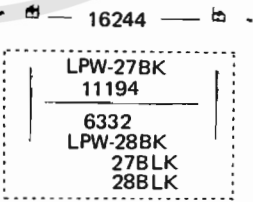
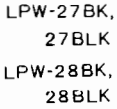
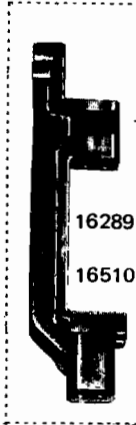
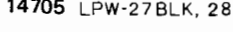
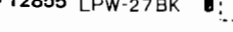
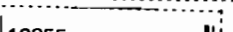
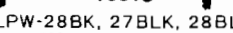
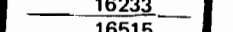
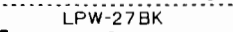
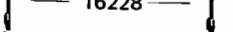
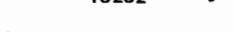
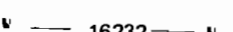
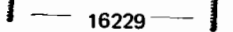
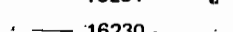
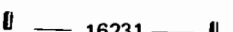
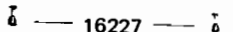
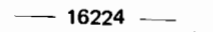
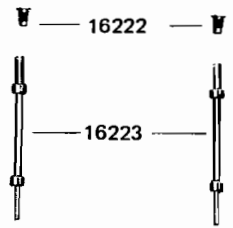

16241

16242

16243

16244

16245

16246

16247

16248

16249

16250

16251

16226

16227

16228

16229

16230

16231

16232

16233

16234

16235

16236



# PRESSER BAR MECHANISM FOR LPW-28BK, 28BLK LPW-28BK, 28BLK, 押え棒関係

10543



10761



10540



16325



10761



10541

10662

10544



10559



10548



10545



10660



10539



10761



10659



10547

10664



10546

lifting presser foot

外押え

10185(1/4'')

(see GAUGE LIST)

ゲージ表参照



10532



10549

# LIFTING ROCK SHAFT MECHANISM FOR LPW-28BK, 28BLK

LPW-28BK, 28BLK, 橫軸關係

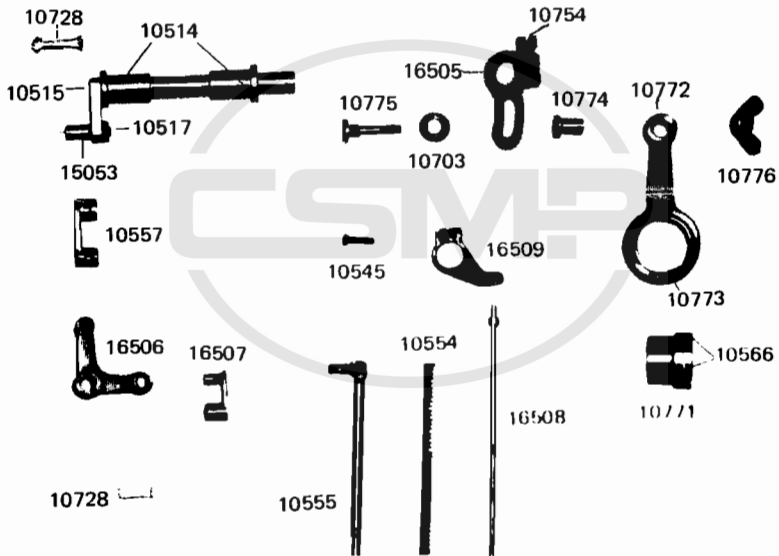

# PRESSER BAR MECHANISM FOR-27BK, 27BLK LPW-27BK, 27BLK, 押え棒関係

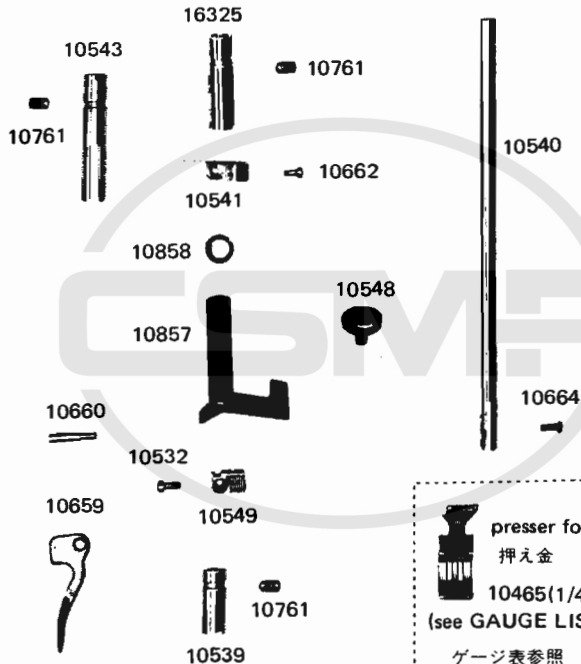

 presser foot  
 押え金  
 10465(1/4")  
 (see GAUGE LIST)  
 ゲージ表参照

# KNEE LIFTER LIFTING LEVER CONNEC TING ROD

弓, 吊り棒関係

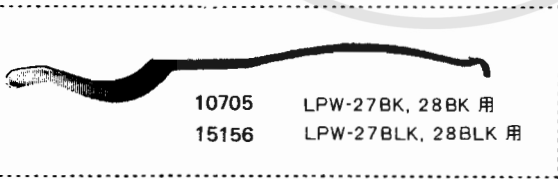
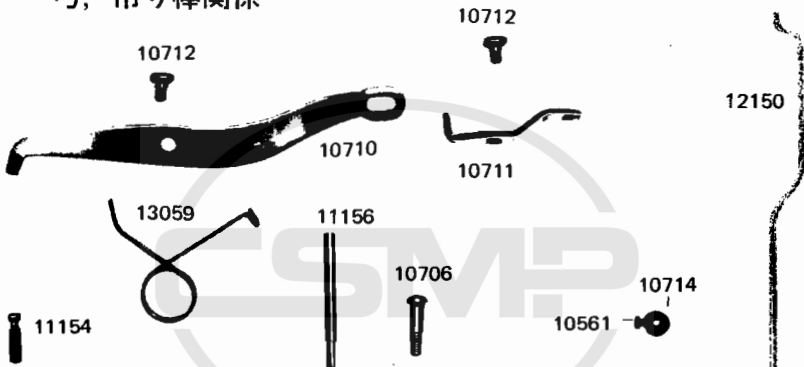

10705 LPW-27BK, 28BK 用  
15156 LPW-27BLK, 28BLK 用

- 10717 U-shaped pin
- 10561 Nut
- 10719 Flat washer
- 10718 Flat washer





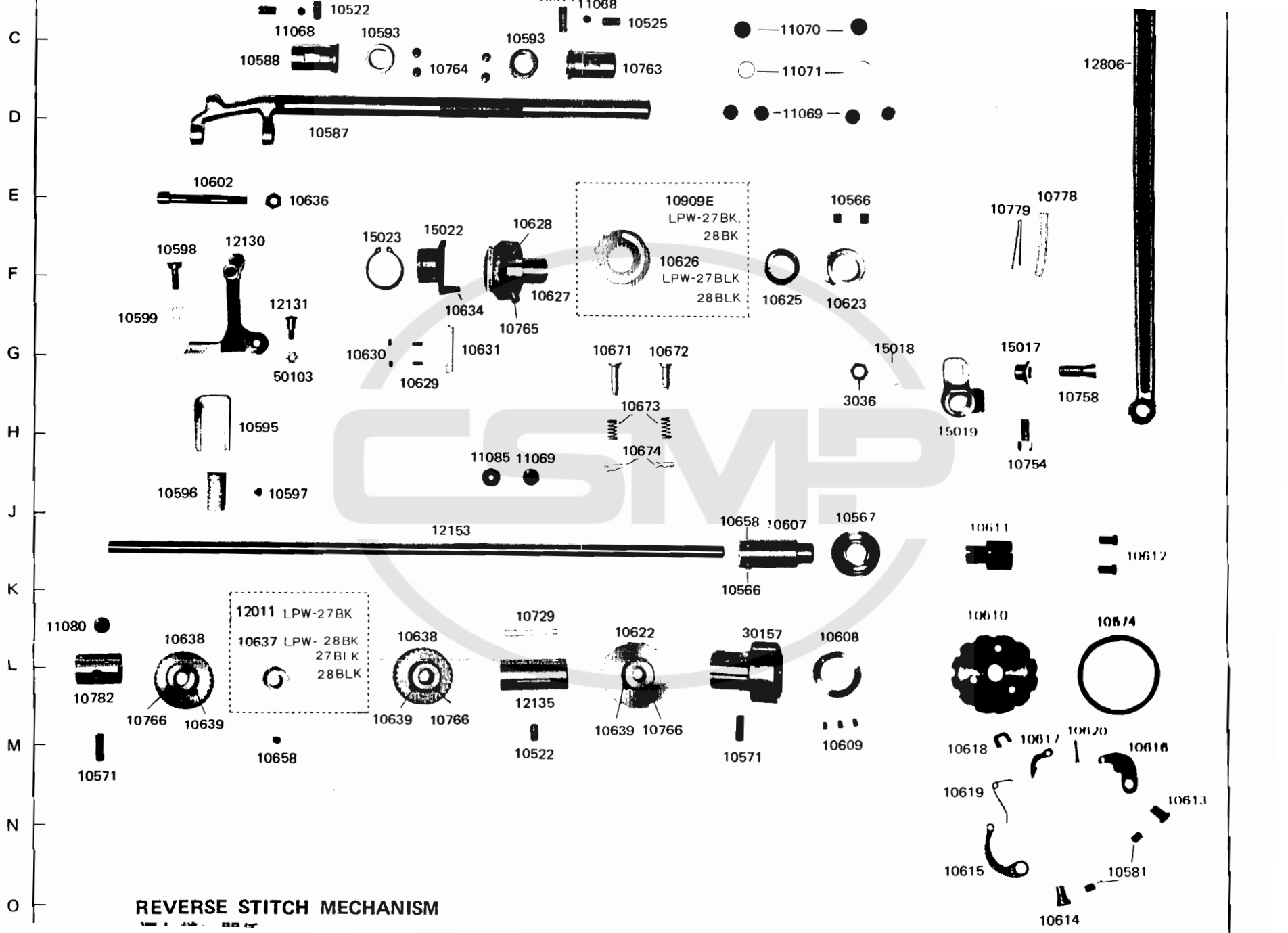

**REVERSE STITCH MECHANISM**

# REVERSE STITCH MECHANISM

## 返し縫い関係

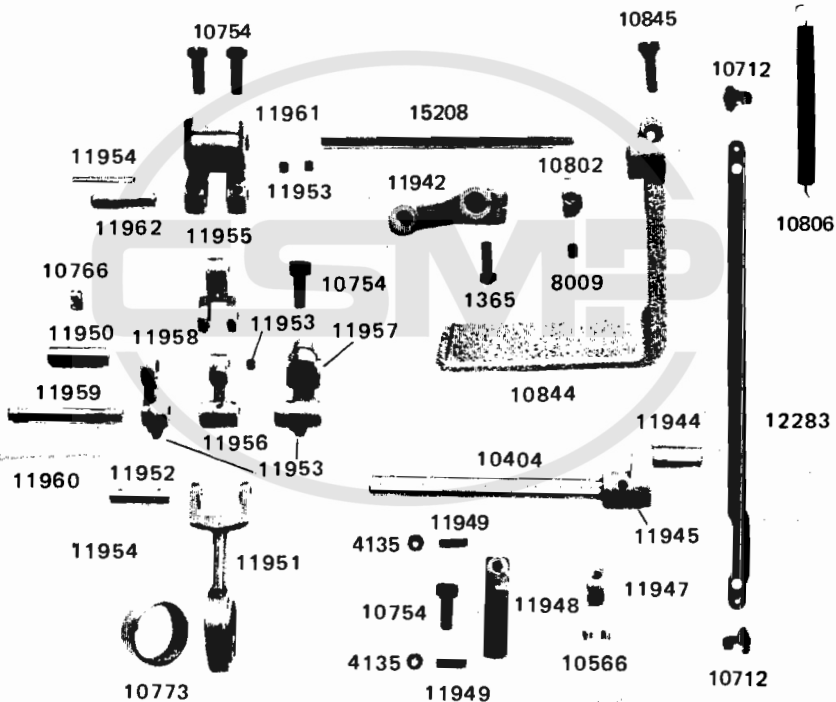



LPW-27BK, 28BK, 27BLK, 28BLK

BELT GUARD (Optional Equipment)  
 ベルトガード (別注品)

LPW-27BK, 28BK

LPW-27BLK, 28BLK

10559

10561

11142

12294-4

50099

14024

50103

12294-1

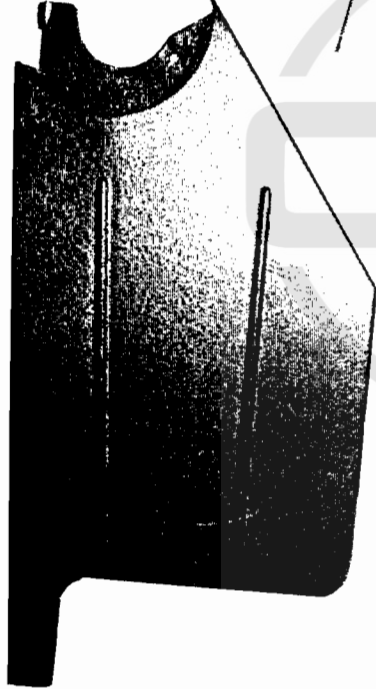

12294-2

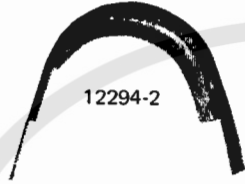

6339

11142

13427

10561

50103

50099

14024

14051

14052

11162

14050

12418

11142

13427

10561

50103

50099

14024

10650

11142



A  
B  
C  
D  
E  
F  
G  
H  
J

1 2 3 4 5 6 7 8 9 10 11 12 13 14 15

ACCESSORIES 付属品

K  
L  
M  
N  
O  
P  
Q  
R  
S  
T  
U  
V

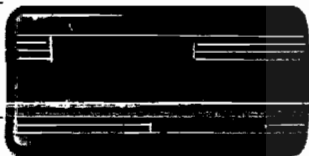

8132

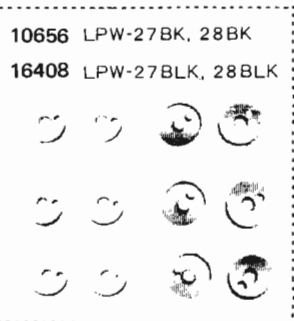

10656 LPW-27BK, 28BK  
16408 LPW-27BLK, 28BLK

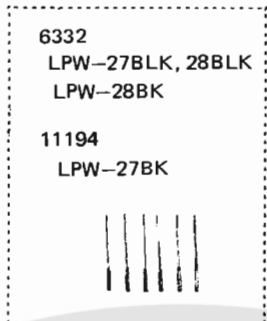

6332 LPW-27BLK, 28BLK  
LPW-28BK  
11194 LPW-27BK



11196

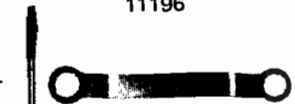

10748

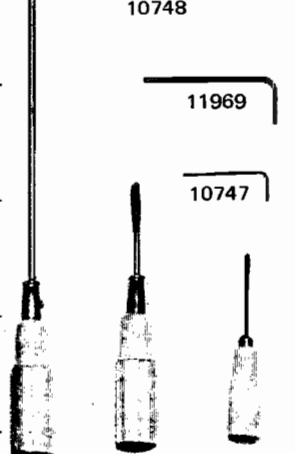

8118 8120 8121

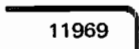

11969



10747



8124



11193



8125

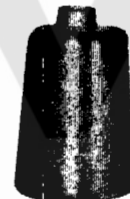

15082

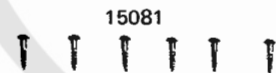

15081

15080



6052

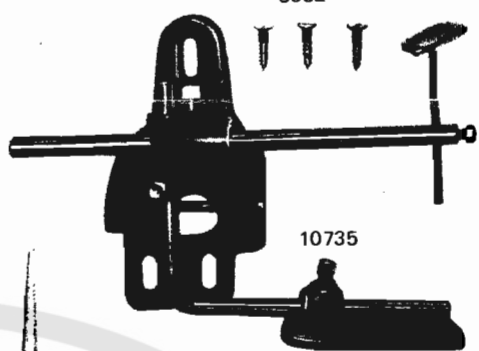

10735

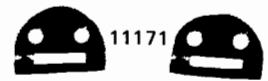

11171



6052

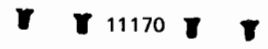

11170



11169

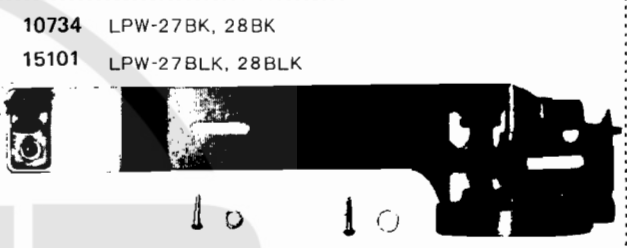

10734 LPW-27BK, 28BK

15101 LPW-27BLK, 28BLK

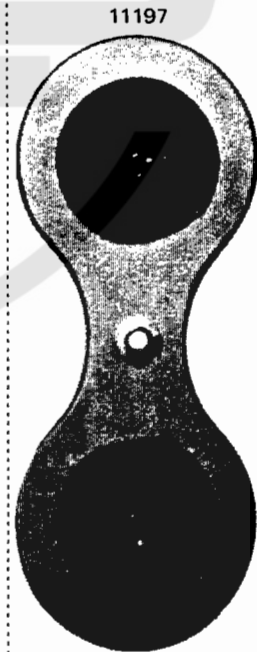

11197

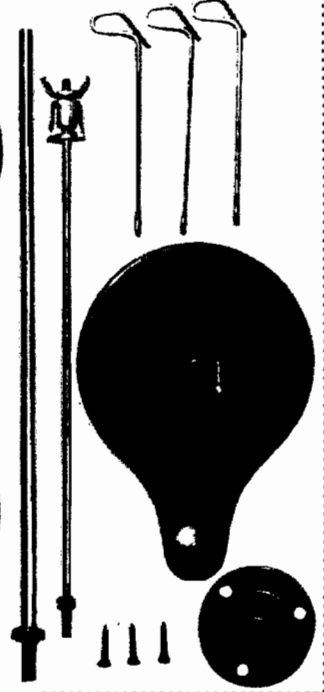

FEED DOG LEVER POST, HOOK SADDLE MECHANISM FOR LPW-27BK, 28BK  
 LPW-27BK, 28BK, 針板土台, カマ土台関係

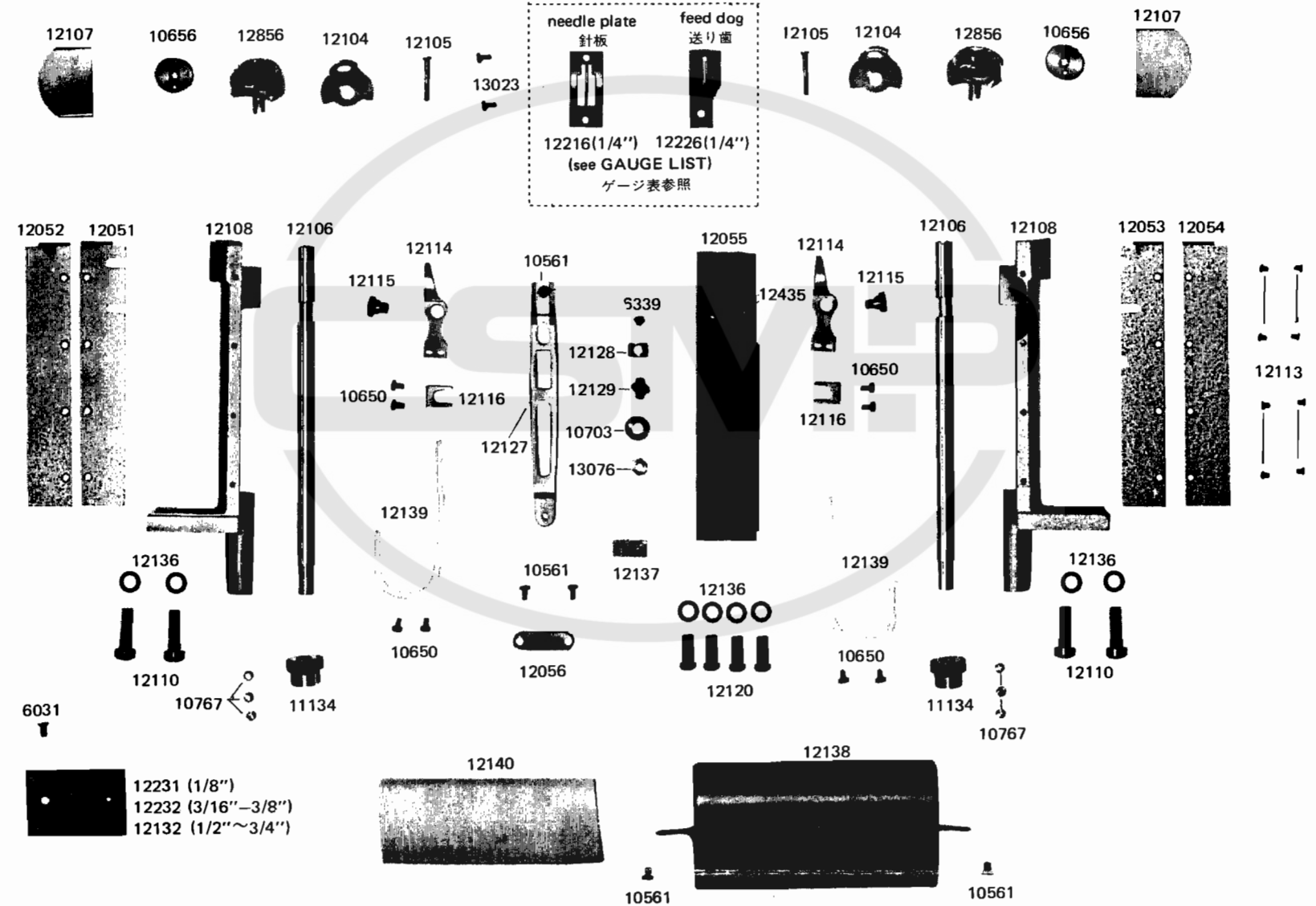

# HOOK カマ

Hook complete number 12856  
カマセット番号



13086-1



12856-9



16407-4



16291-2

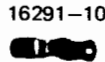

16291-10

16291-8

16407-11

16407-10

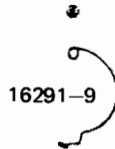

16291-9



**GAUGE LIST FOR LPW-27BK, 28BK**  
**LPW-27BK, 28BK ゲージ表**

common use for LPW-27BK, 28BK

LPW-27BK, 28BK 共通ゲージ

needle calmp

針株



16295 (1/8")  
 16296 (3/16")  
 16297 (7/32")  
 16236 (1/4")  
 16237 (5/16")  
 16238 (3/8")  
 16298 (7/16")  
 16239 (1/2")  
 16303 (5/8")  
 16304 (3/4")

needle plate

針板



12211 (1/8")  
 12213 (3/16")  
 10364 (7/32")  
 12216 (1/4")  
 10366 (5/16")  
 10367 (3/8")  
 10368 (7/16")  
 10369 (1/2")  
 12240 (5/8")  
 12241 (3/4")

feed dog

送り歯



12221 (1/8")  
 12223 (3/16")  
 10394 (7/32")  
 12226 (1/4")  
 10396 (5/16")  
 10397 (3/8")  
 10398 (7/16")  
 10399 (1/2")  
 12250 (5/8")  
 12251 (3/4")

for LPW-27BK

LPW-27BK 用

presser foot

押え金



11212 (1/8")  
 11213 (3/16")  
 10164 (7/32")  
 11214 (1/4")  
 11215 (5/16")  
 11216 (3/8")  
 10168 (7/16")  
 10169 (1/2")  
 10171 (5/8")  
 10172 (3/4")

for LPW-28BK

LPW-28BK 用

lifting presser foot

外押え



10182 (1/8")  
 10183 (3/16")  
 10184 (7/32")  
 10185 (1/4")  
 10186 (5/16")  
 10187 (3/8")  
 10188 (7/16")  
 10189 (1/2")  
 10191 (5/8")  
 10192 (3/4")

vibrating presser foot

中押え



16522 (1/8")  
 16523 (3/16")  
 16524 (7/32")  
 16525 (1/4")  
 16526 (5/16")  
 16527 (3/8")  
 16528 (7/16")  
 16529 (1/2")  
 16531 (5/8")  
 16532 (3/4")

FEED DOG LEVER POST, HOOK SADDLE MECHANISM FOR LPW-27BLK, 28BLK

LPW-27BLK, 28BLK, 針板土台, カマ土台関係

A  
B  
C  
D  
E  
F  
G  
H  
J  
K  
L

1 2 3 4 5 6 7 8 9 10 11 12 13 14 15

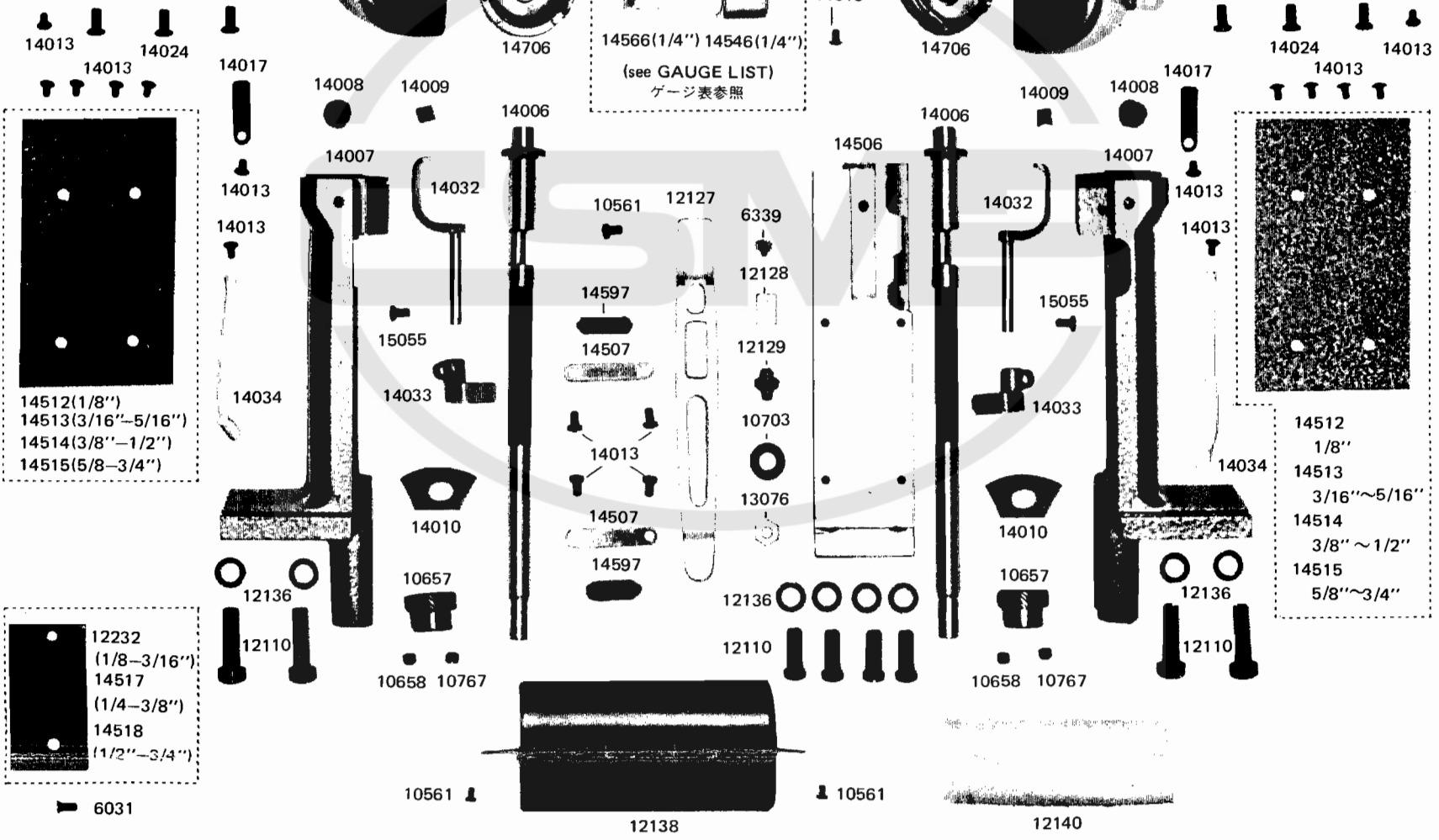

# HOOK

## カマ

Hook complete number

14706

カマセット番号

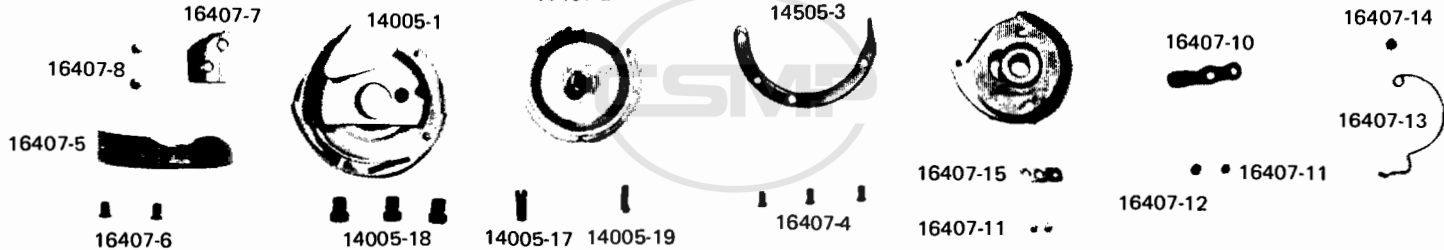

# GAUGE LIST FOR LPW-27BLK, 28BLK

## LPW-27BLK, 28BLK, ゲージ表

common use for LPW-27BLK, 28BLK

LPW-27BLK, 28BLK 共通ゲージ

needle clamp

針株



16295 (1/8")  
16296 (3/16")  
16297 (7/32")  
16236 (1/4")  
16237 (5/16")  
16238 (3/8")  
16239 (1/2")  
16303 (5/8")  
16304 (3/4")

needle plate

針板

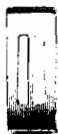

14543 (1/8")  
14545 (3/16")  
14554 (7/32")  
14546 (1/4")  
14547 (5/16")  
14548 (3/8")  
14549 (1/2")  
14550 (5/8")  
14551 (3/4")

feed dog

送り歯



14563 (1/8")  
14565 (3/16")  
14574 (7/32")  
14566 (1/4")  
14567 (5/16")  
14568 (3/8")  
14569 (1/2")  
14570 (5/8")  
14571 (3/4")

base for needle plate

針板受台



14508 (1/8")  
14509 (3/16"-3/8")  
14510 (1/2"-3/4")

base plate for needle plate

針板下板



14523 (1/8")  
14525 (3/16")  
14534 (7/32")  
14526 (1/4")  
14527 (5/16")  
14528 (3/8")  
14529 (1/2")  
14530 (5/8")  
14531 (3/4")

for LPW-27BLK

LPW-27BLK 用

presser foot

押え金



14583 (1/8")  
14585 (3/16")  
14594 (7/32")  
14586 (1/4")  
14587 (5/16")  
14588 (3/8")  
14589 (1/2")  
14590 (5/8")  
14591 (3/4")

for LPW-28BLK

LPW-28BLK 用

vibrating presser foot

外押え



10182 (1/8")  
10183 (3/16")  
10184 (7/32")  
10185 (1/4")  
10186 (5/16")  
10187 (3/8")  
10189 (1/2")  
10191 (5/8")  
10192 (3/4")

vibrating presser foot

中押え



16522T (1/8")  
16523T (3/16")  
16524T (7/32")  
16525T (1/4")  
16526T (5/16")  
16527T (3/8")  
16529T (1/2")  
16531T (5/8")  
16532T (3/4")