

Pfaff

Mauser Spezial 51

Mauser Spezial 53

Mauser Spezial 55

Subclass



PFAFF[®]

MAUSER SPEZIAL

51

53

55

CSMP

Unterklassen-Ausstattung

Subclass parts

Composition des sous-classes

Composición de las subclases

Equipement des sous-classes

Dotación de las subclases

Maschinenklasse Machine class Classe de máquina	Nadelabstand in mm Needle gauge in mm Écartement des aiguilles en mm Distancia entre agujas en mm	Nadelhalter Needle holder Pince-aiguille Portaaguja	Stoffschleiber Feed dog Griffe Transportador inferior	Stoffschleiber, hinten Feed dog, rear Griffe arrière Transportador inferior detrás	Stoffschleiber, vorn Feed dog, front Griffe avant Transportador inferior delante	Stichplatte Needle plate Plaque à aiguille Pieza de aguja	Stoffdrückerfuß Presser foot Pied presseur Pie prensatelas
51							
-23300-01 -990/01	6,0	96-702 044-91		96-712 086-05	96-712 085-05	96-711 570-05	96-711 569-91
53							
-23100-01 (-990/01)	3,5	96-702 034-91	96-710 550-05			96-711 423-05	96-711 415-91
-23100-01 (-990/01) (-990/02)	4,5	96-702 036-91	96-710 550-05			96-711 426-05	96-721 221-93 x 4,5 96-711 424-91 ²⁾
-23100-01 (-990/01)	6,0	96-702 044-91	96-712 108-05			96-711 434-05	96-711 431-91
-23100-02 (-990/01) (-990/02)	4,5	96-702 036-91	96-711 454-05			96-711 453-05	96-711 446-91
-23300-01 (-990/01)	3,5	96-702 034-91		96-710 397-05	96-710 398-05	96-711 423-05	96-721 221-93 x 3,5 96-711 415-91 ²⁾
-23300-01 (-990/01)	4,5	96-702 036-91		96-710 397-05	96-710 398-05	96-711 426-05	96-721 221-93 x 4,5 96-711 424-91 ²⁾
-23300-01	6,0	96-702 044-91		96-712 090-05	96-712 099-05	96-711 434-05	96-711 431-91
-23300-011 -990/01 (-990/02)	4,5	96-702 036-91		96-705 586-05	96-710 398-05	96-705 596-05	96-707 458-91
-23300-02 (-990/01)	3,5	96-702 034-91		96-705 248-05	96-710 398-05	96-711 452-05	96-711 445-91
-23300-02 (-990/01)	4,5	96-702 036-91		96-705 248-05	96-710 398-05	96-711 453-05	96-711 446-91
-23500-020 -990/01	4,5	96-702 036-91	96-711 454-05			96-711 453-05	96-703 668-91
-24301-01	4,5	96-702 036-91		96-705 586-05	96-710 398-05	96-705 596-05	96-705 600-91
-34300-01 (-990/01)	5,4	96-702 030-91		96-705 586-05	96-711 174-05	96-705 593-05	96-706 095-91
-35303-01	3,5 x 4,0	96-702 073-91		96-702 598-05	96-702 725-05	96-711 152-05	96-707 105-91
-35303-02	3,5 x 4,0	96-702 073-91		96-702 598-05	96-702 725-05	96-711 152-05	96-707 105-91
55							
-23300-41 -990/01	4,5	96-702 036-91		96-702 635-05	96-702 616-05	96-705 504-05	96-705 572-91
-23370-41 (-990/01)	3,5	96-702 034-91		96-702 635-05	96-702 616-05	96-705 834-05	96-707 852-91 96-705 574-91 ²⁾
-23370-41 -990/01	4,5	96-702 036-91		96-702 635-05	96-702 616-05	96-706 010-05	96-707 853-91 96-705 572-91 ²⁾
-23500-01	3,5	96-702 034-91	96-711 503-05 96-711 502-05 ²⁾			96-711 442-05	96-711 437-91

* Zusätzlich Kordelführung Nr. 96-780 080-90 erforderlich
Fancy thread guide No. 96-780 080-90 required in addition
Guide-corde n° 96-780 080-90 nécessaire en plus
La guía para cordoncillo N° 96-780 080-90 se requiere adicionalmente

¹⁾ = Nähmuster einsenden
= Submit sewing sample
= Joindre échantillons de couture
= Enviar muestra de costura

²⁾ = Eingeklammerte Zahl = Standardmaß, sonstige nach Bestellung
= Number in parentheses = standard dimension; other dimensions on order
= Chiffre entre parenthèses = mesure standard; autres mesures sur commande
= Cifra entre paréntesis = medida estándar; otras medidas, sobre demanda

²⁾ = Sonderausführung
= Special version
= Version spéciale
= Tipo especial

**Equipement des sous-classes
Unterklassen-Ausstattung**

**Dotación de las subclases
Subclass organization**

Maschinenklasse Machine class Clase de máquina	Greifer Looper Boucleur Garfio	Greifer hinten Looper rear Boucleur arrière Garfio detrás	Nadelanschlag Needle stop Pare-aiguille Tope de la aguja	Stoffanschlag Fabric guide Guide-bord Guía tope	Appareil [1][2][7] Attachment Appareil Aparato	Träger Bracket Support Soporte	Saumwinkel Hem guide Guide-bord Guía tope	Gummibandführung Elastic tape guide Guide-élastique Guía para elásticos	Fingerschutz Finger guard Protecteur doigts Salvadoedós
51									
-23300-01 -990/01	96-712 082-05		96-707 394-05	96-712 093-25					96-707 1
53									
-23100-01 (-990/01)	96-712 082-05		96-707 394-05	96-705 459-25			96-710 427-25		96-707 1
-23100-01 (-990/01) (-990/02)	96-712 082-05		96-707 394-05	96-705 459-25			96-710 427-25		96-707 1
-23100-01 (-990/01)	96-712 082-05		96-707 394-05	96-705 459-25			96-710 427-25		96-707 1
-23100-02 (-990/01) (-990/02)	96-712 082-05		96-707 394-05	96-705 459-25 96-712 109-21					96-707 1
-23300-01 (-990/01)	96-712 082-05		96-707 394-05	96-705 459-25			96-710 427-25		96-707 1
-23300-01 (-990/01)	96-712 082-05		96-707 394-05	96-705 459-25			96-710 427-25		96-707 1
-23300-01	96-712 082-05		96-707 394-05	96-705 459-25			96-710 427-25		96-707 1
-23300-011 -990/01 (-990/02)	96-712 082-05		96-707 394-05	96-705 459-25			96-710 427-25		96-707 1
-23300-02 (-990/01)	96-712 082-05		96-707 394-05	96-705 459-25 96-712 109-21					96-707 1
-23300-02 (-990/01)	96-712 082-05		96-707 394-05	96-705 459-25 96-712 109-21					96-707 1
-23500-020 -990/01	96-712 082-05		96-707 394-05	96-712 109-21					96-707 1
-24301-01	96-712 082-05		96-707 394-05	96-705 459-25			96-710 427-25		
-34300-01 (-990/01)	96-712 082-05		96-707 394-05	96-705 459-25 96-712 109-21					96-707 1
-35303-01	96-712 082-05		96-702 599-05	96-705 459-25			96-703 857-25		96-707 1
-35303-02	96-712 082-05		96-702 599-05	96-705 459-25			96-703 857-25		96-707 1
55									
-23300-41 -990/01	96-712 082-05		96-707 394-05	96-705 160-05		96-706 995-91		96-705 529-91	96-707 1
-23370-41 (-990/01)	96-712 082-05		96-707 394-05	96-705 160-05		96-706 995-91		96-705 529-91	96-707 1
-23370-41 -990/01	96-712 082-05	96-702 597-05	96-707 394-05	96-705 160-05		96-706 995-91		96-705 529-91	96-707 1
-23500-01	96-712 082-05	96-702 597-05	96-707 394-05		96-712 119-91	96-706 017-55			96-707 1

** siehe Abbildung
see illustration
voir figure
véase figura

 = Abbildung siehe Bestandsliste
= For illustration see spare parts catalogue
= Figure, voir liste de pièces détachées
= Figura, véase la lista de piezas de recambio

Unterklassen-Ausstattung

Subclass organization

Equipement des sous-classes

Dotación de las subclases

Maschinenklasse Machine class Classe de machine Clase de máquina	Fadenführer Thread lubricator Huileur de fil Lubrificador del hilo	Stoffabfallekanal Fabric chute Goulotte d'évacuation Conducto para recortes	Hakenmesser Hook knife Couteau-crochet Cuchilla de gancho	Untermesser Lower knife Couteau inférieur Cuchilla inferior	Roller hinten Guide roll, rear Galet à l'arrière Rodillo detrás	Roller vorn Guide roll, front Galet à l'avant Rodillo delante	Streckstange Stretch tool Barre d'étirage Barra para dar de sí	Zughebel Control lever Tirant Palanca de tracción
51								
-23300-01 -990/01								
53								
-23100-01 (-990/01)								
-23100-01 (-990/01)								
-23100-01 (-990/02)								
-23100-01 (-990/01)								
-23100-02 (-990/01) (-990/02)	96-780 014-91							
-23300-01 (-990/01)								
-23300-01 (-990/01)								
-23300-01								
-23300-011 -990/01 (-990/02)								
-23300-02 (-990/01)	96-780 014-91							
-23300-02 (-990/01)	96-780 014-91							
-23500-020 -990/01	96-780 014-91							
-24301-01								
-34300-01 (-990/01)								
-35303-01								
-35303-02								
55								
-23300-41 -990/01					96-702 069-91	96-707 055-91		
-23370-41 (-990/01)		96-706 749-21 96-710 715-51	96-705 142-05	96-705 138-05	96-702 069-91	96-707 055-91		
-23370-41 -990/01		96-706 749-21 96-710 715-51	96-705 142-05	96-705 138-05	96-702 069-91	96-707 055-91		
-23500-01							96-703 496-91	96-750 253-

Fortsetzung siehe nächste Seite
Continued on next page
Suite voir page suivante
Continúa en la página siguiente

Unterklassen-Ausstattung

Subclass organization

Equipement des sous-classes

Dotación de las subclases

Maschinenklasse Machine class Classe de machine Clase de máquina	Nadelabstand in mm Needle gauge in mm Écartement des aiguilles Distancia entre agujas en mm	Nadelhalter Needle holder Pinça-aiguille Portaaguja	Stoffschieber Feed dog Griffe Transportador inferior	Stoffschieber, hinten Feed dog, rear Griffe Transportador inferior detrás	Stoffschieber, vorn Feed dog, front Griffe avant Transportador inferior delante	Stichplatte Stitch plate Plaque à aiguille Placa de aguja	Stoffdrückerfuß Presser foot Pied presseur Pie prensateelas
55 -23500-01 (-990/01)	4,5	96-702 036-91	96-711 503-05 96-711 502-05			96-711 443-05	96-711 438-91
-23500-01 -990/01	6,0	96-702 044-91	96-707 258-05			96-707 257-05	96-707 255-91
-23500-02 -990/01	3,5	96-702 034-91	96-711 503-05			96-711 442-05	96-711 437-91
-23500-02 (-990/01)	4,5	96-702 036-91	96-711 503-05			96-711 443-05	96-711 438-91
-23500-04 -990/01	4,5	96-702 036-91	96-711 503-05 96-711 502-05			96-711 443-05	96-711 438-91
-23500-05 -990/01	4,5	96-702 036-91	96-706 151-05			96-706 101-05	96-706 125-91
-23500-06 -990/01	3,5	96-702 034-91	96-711 503-05 96-711 502-05			96-711 442-05	96-711 036-91
-23500-06 -990/01	4,5	96-702 036-91	96-711 503-05 96-711 502-05			96-711 443-05	96-711 037-91
-34300-41	5,4	96-702 030-91		96-702 635-05	96-702 616-05	96-705 749-05	96-707 854-91 96-705 530-91
-34300-45* (-990/01) (-990/02)	5,4	96-702 030-91		96-712 116-05	96-712 117-05	96-712 114-05	96-705 530-91
-34370-41 (-990/01)	5,4	96-702 030-91		96-702 635-05	96-702 616-05	96-702 618-05	96-707 854-91 96-705 530-91
-34370-410 (-990/01) (-990/02)	5,4	96-702 030-91		96-702 635-05	96-706 807-05	96-706 806-05	96-705 530-91
-35301-41	5,4	96-702 030-91		96-702 635-05	96-702 616-05	96-705 749-05	96-707 856-91
-35301-45*	5,4	96-702 030-91		96-712 116-05	96-712 117-05	96-712 114-05	96-702 051-91
-35371-41	5,4	96-702 030-91		96-702 635-05	96-702 616-05	96-706 618-05	96-707 856-91

* Zusätzlich Kniehebel Nr. 96-712 113-90 erforderlich
Knee-lever No. 96-712 113-90 required in addition
Genouillère n° 96-712 113-90 nécessaire en plus
La palanca de rodilla N° 96-712 113-90 se requiere adicionalmente

= Nähmuster einsenden
= Submit sewing sample
= Joindre échantillons de couture
= Envíese muestra de costura

= Eingeklammerte Zahl = Standardmaß, sonstige nach Bestellung
= Number in parentheses = standard dimension; other dimensions on order
= Chiffre entre parenthèses = mesure standard; autres mesures sur commande
= Cifra entre paréntesis = medida estándar; otras medidas, sobre demanda

= Sonderausführung
= Special version
= Version spéciale
= Tipo especial

Unterklassen-Ausstattung

Subclass organization

Maschinenklasse Machine class Clase de máquina	Greifer Looper Boucleur Ganito	Nadelanschlag Needle stop Para-alquile Tope de la aguja	Stoffanschlag Fabric guide Guide-board Guía tope	Apparat  Attachment Aparato	Träger Bracket Support Supporte	Saumwinkel Hem guide Guide-board Guía tope	Gummibandführung Elastic tape guide Guide-elasticus Guiá para elásticos	Fingerschutz Finger guard Protège-doeils Salvadedos	Fadenbinder Thread lubricator Huileur de fil Lubrificador del hilo
-23500-01 (-990/01)	96-712 082-05	96-707 394-05		96-712 119-91	96-706 017-55			96-707 139-15	
-23500-01 -990/01	96-712 082-05	96-707 394-05		96-712 119-91	96-706 017-55			96-707 139-15	
-23500-02 -990/01	96-712 082-05	96-707 394-05		96-705 648-91	96-705 489-55			96-707 139-15	96-780 014-91
-23500-02 (-990/01)	96-712 082-05	96-707 394-05		96-705 648-91	96-705 489-55			96-707 139-15	96-780 014-91
-23500-04 -990/01	96-712 082-05	96-707 394-05			96-706 017-55	96-705 254-91	96-705 556-91	96-707 139-15	
-23500-05 -990/01	96-712 082-05	96-707 394-05		96-712 119-91	96-706 017-55			96-707 139-15	
-23500-06 -990/01	96-712 082-05	96-707 394-05			96-706 017-55	96-705 254-91	96-705 556-91	96-707 139-15	
-23500-06 -990/01	96-712 082-05	96-707 394-05			96-706 017-55	96-705 254-91	96-705 556-91	96-707 139-15	
-34300-41	96-712 082-05	96-707 394-05	96-705 160-05		96-706 995-91		96-705 529-91	96-707 139-15	
-34300-45* (-990/01) (-990/02)	96-712 082-05	96-707 394-05		96-701 387-91 (85 x 35)	96-706 995-91			96-707 139-15	
-34370-41 (-990/01)	96-712 082-05	96-707 394-05	96-705 160-05		96-706 995-91		96-705 529-91	96-707 139-15	
-34370-410 (-990/01) (-990/02)	96-712 082-05	96-707 394-05	96-705 160-05		96-706 995-91			96-707 139-15	
-35301-41	96-712 082-05	96-707 394-05	96-705 160-05		96-706 995-91		96-705 529-91		
-35301-45*	96-712 082-05	96-707 394-05		96-702 658-91 (60 x 30)	96-706 995-91				
-35371-41	96-712 082-05	96-707 394-05	96-705 160-05		96-706 995-91		96-705 529-91		

Weitere Umbauteile bitten wir aus der Bestandteilliste zu entnehmen
 For additional conversion parts please refer to the spare parts catalogue
 Pour les autres pièces de transformation, voir liste de pièces détachées
 Para las otras piezas de transformación, véase la lista de piezas de recambio

** siehe Abbildung
 see illustration
 voir figure
 véase figura

 = Abbildung siehe Bestandteilliste
 = For illustration see spare parts catalogue
 = Figure, voir liste de pièces détachées
 = Figura, véase la lista de piezas de recambio

Unterklassen-Ausstattung
Equipement des sous-classes

Subclass organization
Dotación de las subclases

Maschinenklasse Machine class Clase de máquina	Stofffabrikanteil Fabrication Contenido d'abricacion Contenido para recortas	Hakenmesser Hook knife Couteau-crochet Cuchilla de gancho	Untermesser Lower knife Couteau inférieur Cuchilla inferior	Rolle hinten Guide roll, rear Galet à l'arrière Rodillo detrás	Rolle vorn Guide roll, front Galet à l'avant Rodillo delante	Streckstange Stretch rod Barre d'étrépage Barra para dar de sí	Zughebel Control lever Trant Palanca de tracción	Niederhalter Work retainer Pied de maintien Pie de retención
55								
-23500-01 (-990/01)						96-703 496-91	96-750 253-92	
-23500-01 -990/01						96-703 496-91	96-750 253-92	
-23500-02 -990/01							96-781 051-91	
-23500-02 (-990/01)							96-781 051-91	
-23500-04 -990/01						96-703 496-91	96-750 253-92	
-23500-05 -990/01						96-703 496-91	96-750 253-92	
-23500-06 -990/01						96-703 496-91	96-750 253-92	
-23500-06 -990/01						96-703 496-91	96-750 253-92	
-34300-41				96-702 069-91	96-707 055-91			
-34300-45* (-990/01) (-990/02)				96-702 069-91	96-707 055-91			
-34370-41 (-990/01)	96-706 749-21 96-710 715-51	96-705 142-05	96-705 138-05	96-702 069-91	96-707 055-91			
-34370-410 (-990/01) (-990/02)	96-706 749-21 96-710 715-51	96-705 142-05	96-705 138-05	96-702 069-91	96-707 055-91			96-707 287-91
-35301-41				96-702 069-91	96-707 055-91			
-35301-45*				96-702 069-91	96-707 055-91			
-35371-41	96-706 749-21 96-710 715-51	96-705 142-05	96-705 138-05	96-702 069-91	96-707 055-91			

96-702 030-91

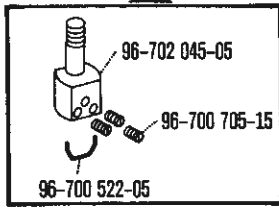

53-34300-01
 55-34300-41
 55-34300-45
 55-34370-41
 55-34370-410
 55-35301-41
 55-35301-45
 55-35371-41

96-702 034-91

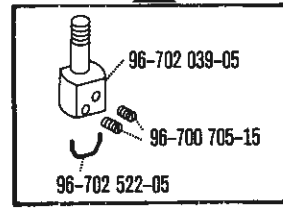

53-23100-01
 53-23300-01
 53-23300-02
 55-23370-41
 55-23500-01
 55-23500-02
 55-23500-06

96-702 036-91

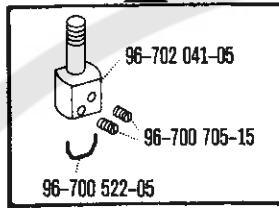

53-23100-01
 53-23100-02
 53-23300-01
 53-23300-01
 53-23300-02
 53-23500-020
 53-24301-01
 55-23300-41
 55-23370-41
 55-23500-01
 55-23500-02
 55-23500-04
 55-23500-05
 55-23900-06

96-702 044-91

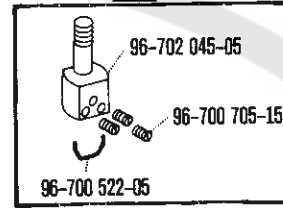

51-23300-01
 53-23100-01
 53-23300-01
 55-23500-01

96-702 073-91

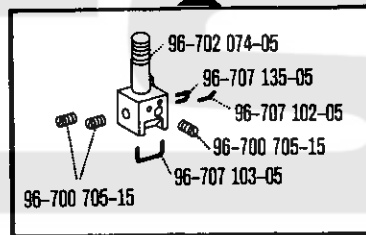

53-35303-01
 53-35303-02

96-706 151-05

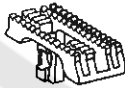

55-23500-06

96-707 258-05



55-23500-01

96-710 550-05



53-23100-01

96-711 454-05



53-23100-02
 53-23500-020

96-711 502-05

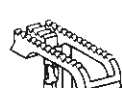

55-23500-01
 55-23500-04
 55-23500-06

96-711 503-05

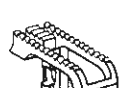

55-23500-01
 55-23500-02
 55-23500-04
 55-23500-06

96-712 108-05



53-23100-01

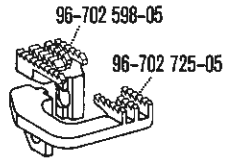

53-35303-01
53-35303-02

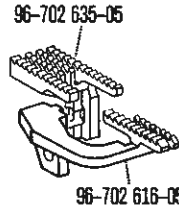

55-23300-41 55-34370-41
55-23370-41 55-35301-41
55-34300-41 55-35371-41

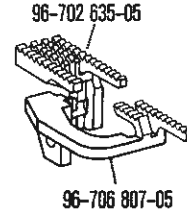

55-34370-410

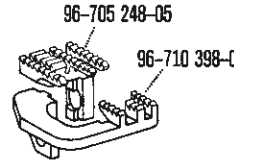

53-23300-02

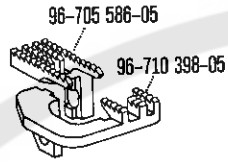

53-23300-01
53-24301-01

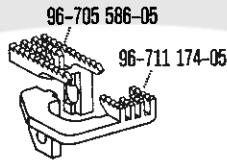

53-34300-01

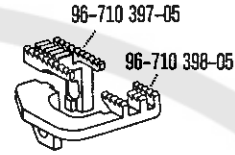

53-23300-01

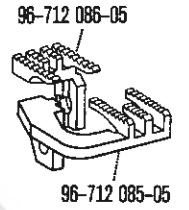

51-23300-01

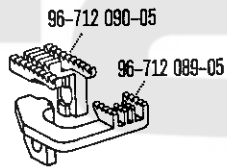

53-23300-01

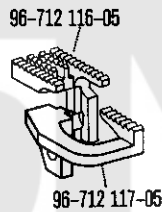

55-34300-45
55-35301-45

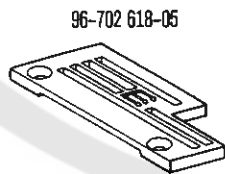

55-34370-41
55-35371-41

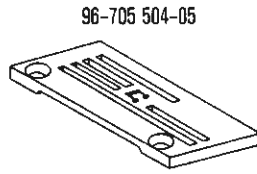

55-23300-41

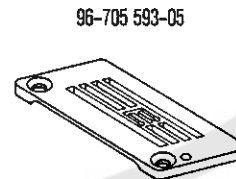

53-34300-01

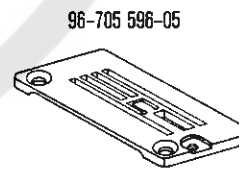

53-23300-011
53-24301-01

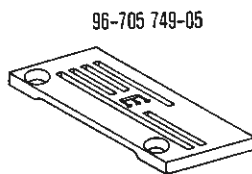

55-34300-41
55-35301-41

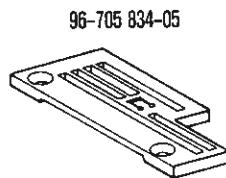

55-23370-41

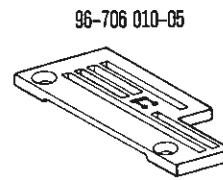

55-23370-41

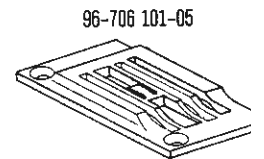

55-23500-05

96-706 806-05

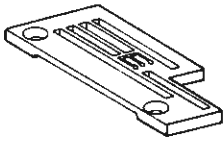

55-34370-410

96-707 257-05

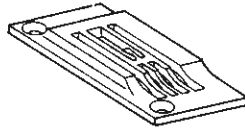

55-23500-01

96-711 152-05

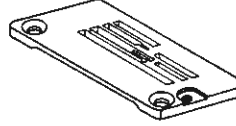

53-35303-01
53-35303-02

96-711 423-05

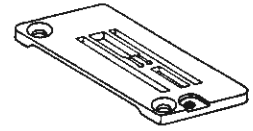

53-23 100-01
53-23300-01

96-711 426-05

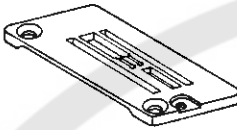

53-23 100-01
53-23300-01

96-711 434-05

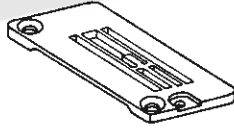

53-23 100-01
53-23300-01

96-711 442-05

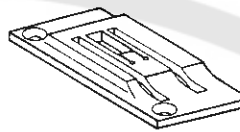

55-23500-01
55-23500-02
55-23500-06

96-711 443-05

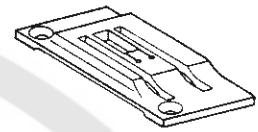

55-23500-01
55-23500-02
55-23500-04
55-23500-06

96-711 452-05

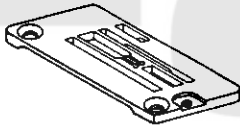

53-23300-02

96-711 453-05

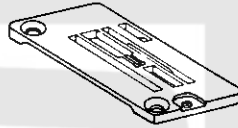

53-23 100-02
53-23300-02
53-23500-020

96-711 570-05

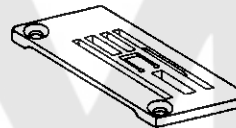

51-23300-01

96-712 114-05

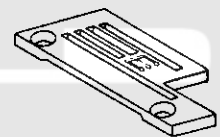

55-34300-45
55-3530 1-45

96-702 051-91

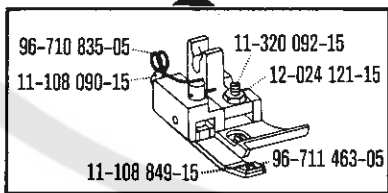

55-3530 1-45

96-703 668-91

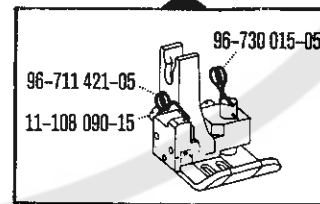

53-23500-020

96-705 530-91

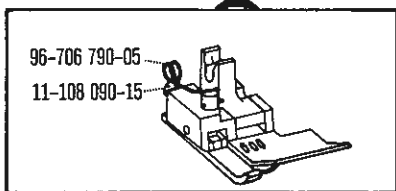

55-34300-41
55-34300-45
55-34370-41
55-34370-410

96-705 572-91

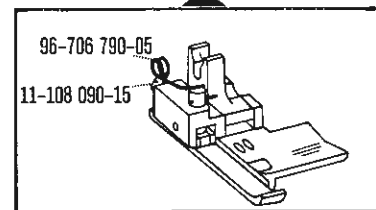

55-23300-41
55-23370-41

96-705 574-91

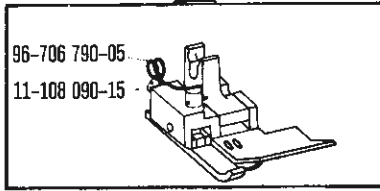

55-23370-41

96-705 600-91

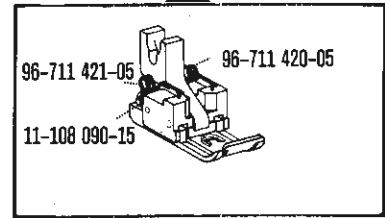

53-24301-01

96-706 095-91

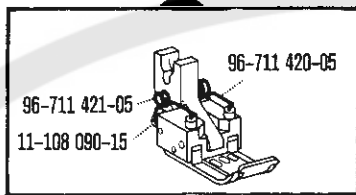

53-34300-01

96-706 125-91

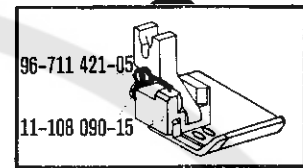

55-23500-05

96-707 105-91

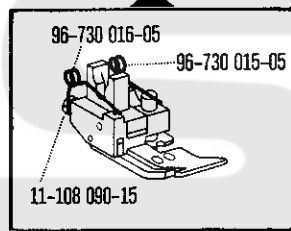

53-35303-01
53-35303-02

96-707 255-91

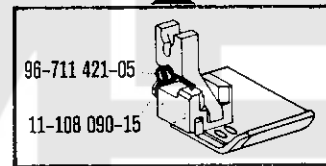

55-23500-01

96-707 458-91

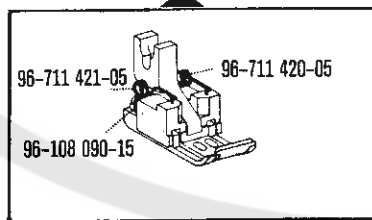

53-23300-011

96-707 852-91

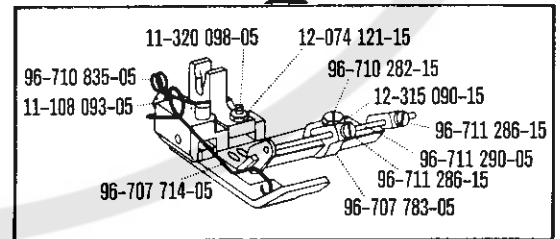

55-23370-41

96-707 853-91

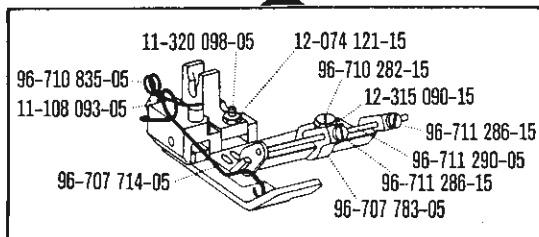

55-23370-41

96-707 854-91

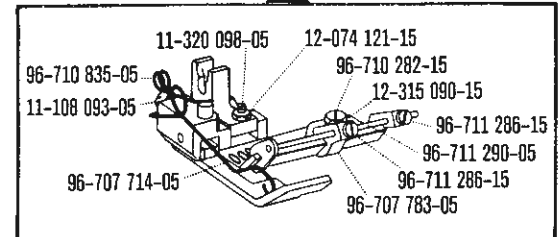

55-34300-41
55-34370-41

96-707 856-91

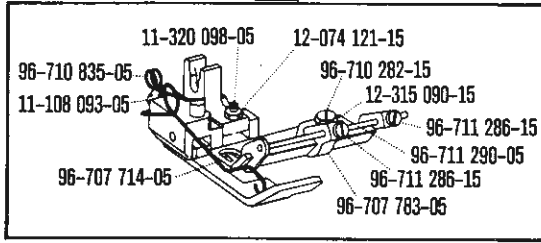

55-35301-41

55-35371-41

96-711 036-91

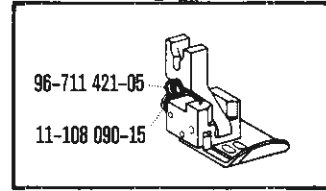

55-23500-06

96-711 037-91

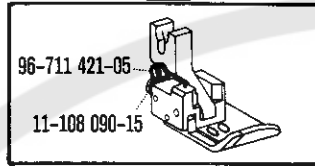

55-23500-06

96-711 415-91

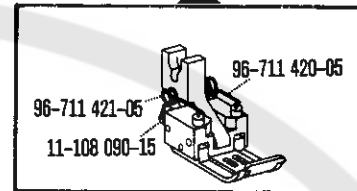

53-23 100-01
53-23300-01

96-711 424-91

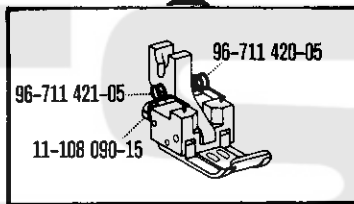

53-23 100-01
53-23300-01

96-711 431-91

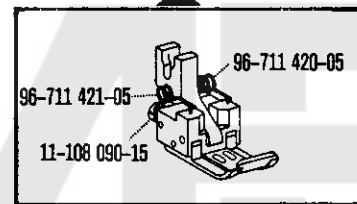

53-23 100-01
53-23300-01

91-711 437-91

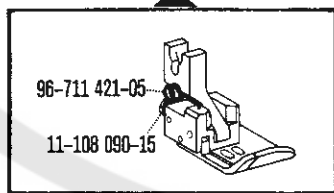

55-23500-01
55-23500-02

96-711 438-91

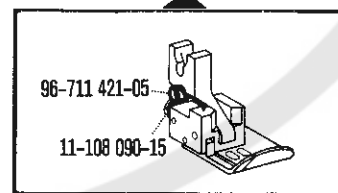

55-23500-01
55-23500-02
55-23500-04

96-711 445-91

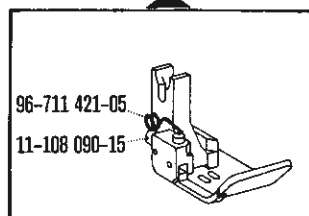

53-23300-02

96-711 446-91

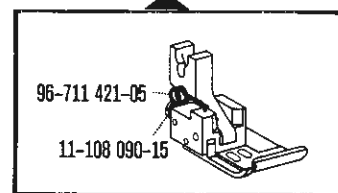

53-23 100-02
53-23300-02

96-711 569-91

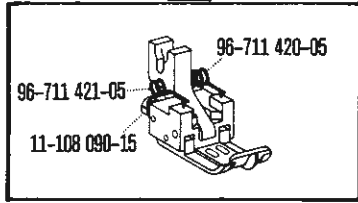

51-23300-01

96-721 221-93

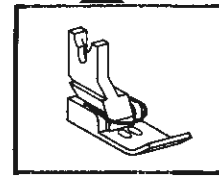

53-23 100-01
53-23300-01

96-712 082-05

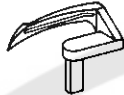

51-23300-01
53-23 100-01
53-23 100-02
53-23300-01
53-23300-01

53-23300-02
53-23500-020
53-2430 1-01
53-34300-01
53-35303-01

53-35303-02
55-23300-41
55-23370-41
55-23500-01
55-23500-02
55-23500-04
55-23500-05
55-23500-06

55-34300-41
55-34300-45
55-34370-41
55-34370-410
55-3530 1-41
55-3530 1-45
55-3537 1-41

96-702 597-05

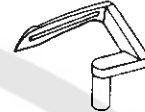

55-23370-41
55-23500-01

96-702 599-05



11-108 090-15

53-35303-01
53-35303-02

96-707 394-05



11-108 090-15

51-23300-01
53-23 100-01
53-23 100-02
53-23300-01

53-23300-011
53-23300-02
53-23500-020
53-2430 1-01

53-34300-01
55-23300-41
55-23370-41
55-23500-01
55-23500-02
55-23500-04
55-23500-06

55-23500-06
55-34300-41
55-34300-45
55-34370-41
55-34370-410
55-3530 1-41
55-3530 1-45
55-3537 1-41

96-705 160-05



96-710 189-15

55-23300-41
55-23370-41
55-34300-41
55-34370-41

55-34370-410
55-3530 1-41
55-3537 1-41

96-702 292-15

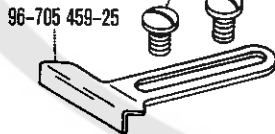

53-23 100-01
53-23 100-02
53-23300-01
53-23300-011
53-23300-02

53-2430 1-01
53-34300-01
53-35303-01
53-35303-02

96-712 093-25

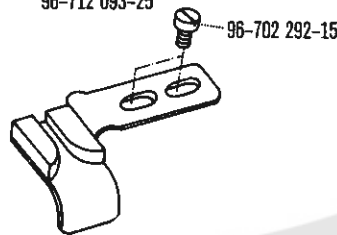

51-23300-01

96-712 109-25



11-108 171-15

53-23 100-02
53-23300-02
53-23500-020
53-34300-01

96-710 428-15



96-703 857-25

53-35303-01
53-35303-02

96-705 254-91

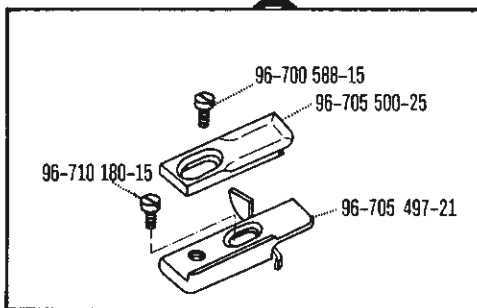

55-23500-04
55-23500-06

96-710 428-15



96-710 427-25

53-23 100-01
53-23300-01
53-23300-011
53-2430 1-01

96-701 387-91

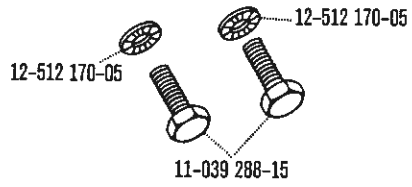
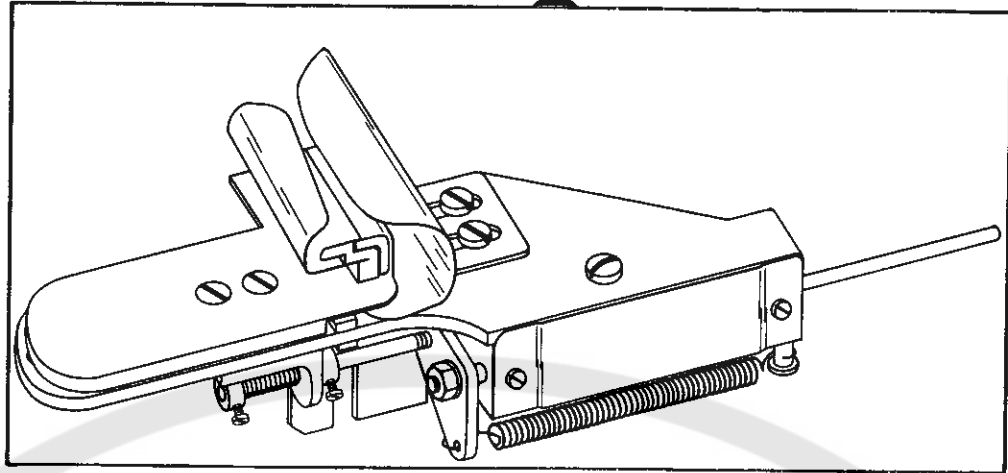

55-34300-45

96-702 658-91

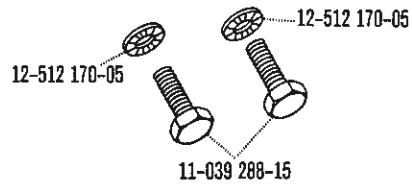
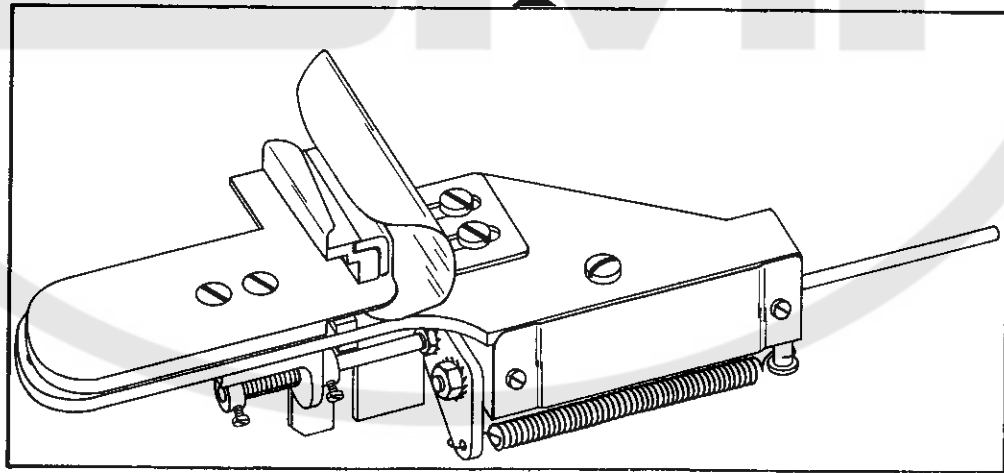

55-35301-41

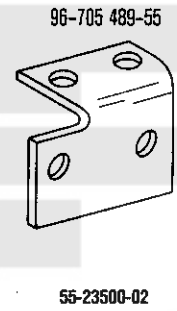
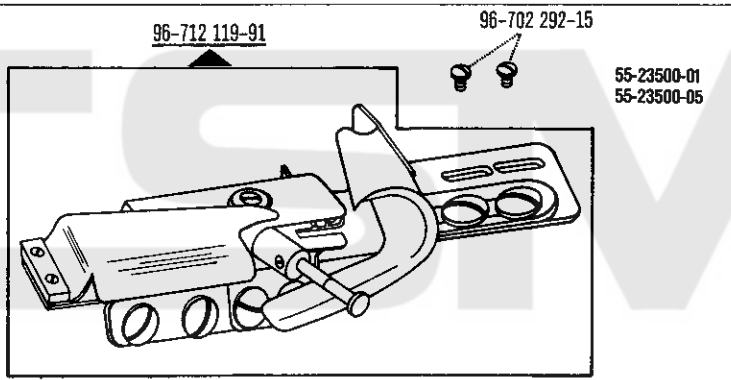
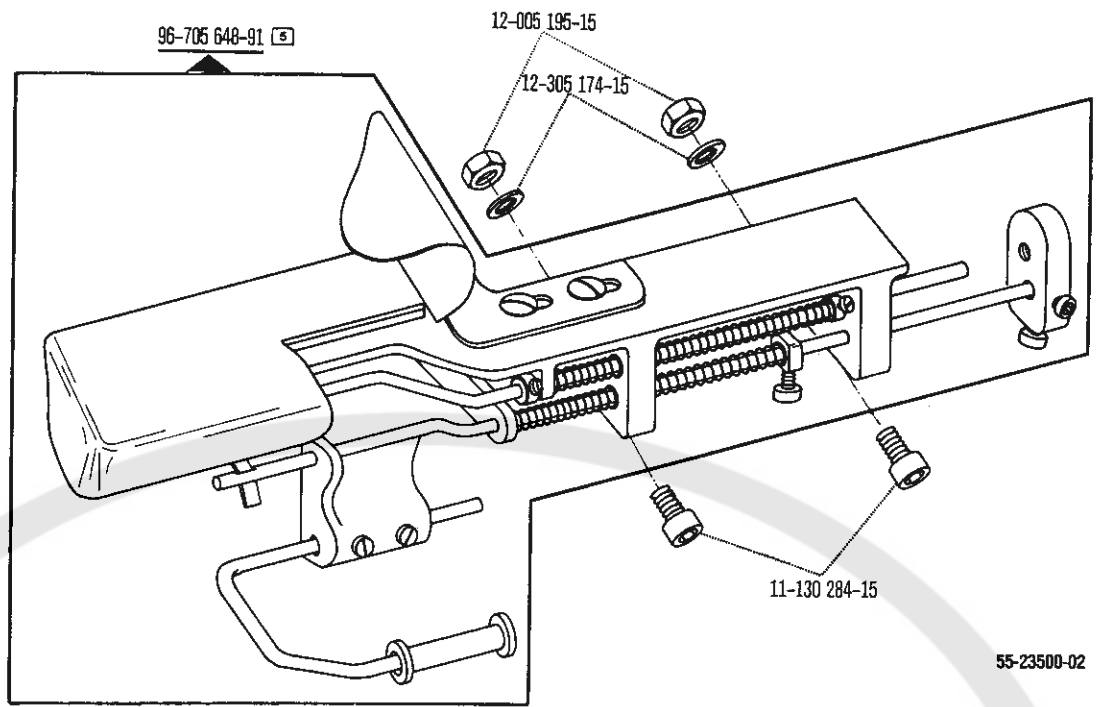

96-706 017-55



55-23500-01
55-23500-04
55-23500-05
55-23500-06

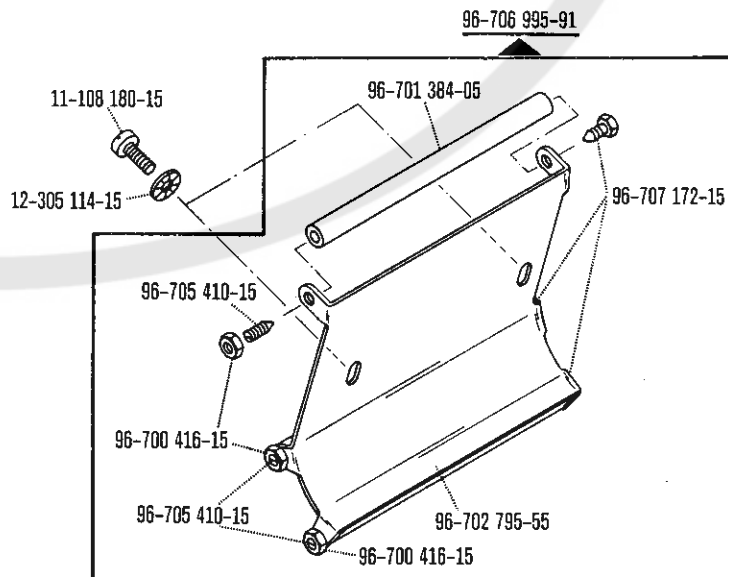

55-23300-41
55-23370-41
55-23370-41
55-34300-41

55-34300-45
55-34370-41
55-34370-410

55-35301-41
55-35301-45
55-35371-41

96-705 529-91

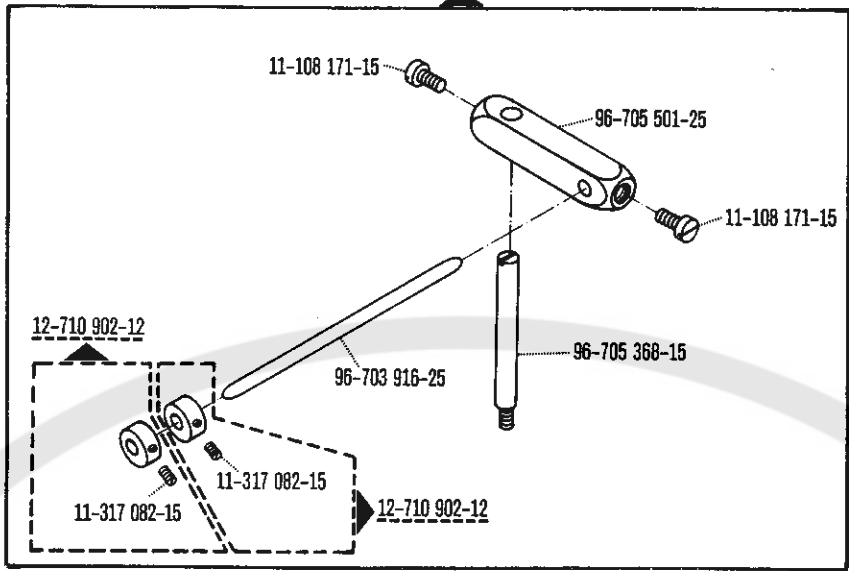

55-23300-41
 55-23370-41
 55-34300-41
 55-34370-41
 55-35301-41
 55-35371-41

96-705 556-91

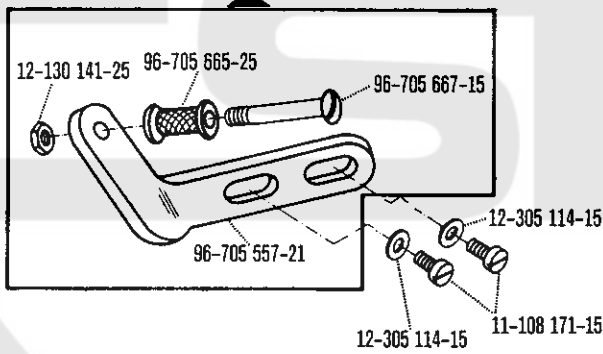

55-23500-04
 55-23500-06

96-780 014-91

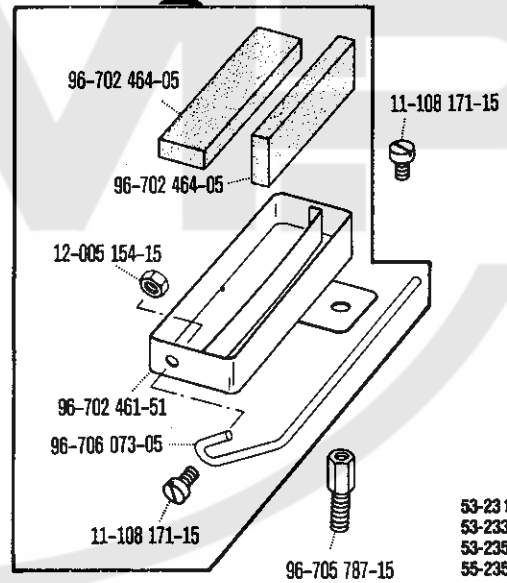

53-23 100-02
 53-23300-02
 53-23500-020
 55-23500-02

96-706 749-21

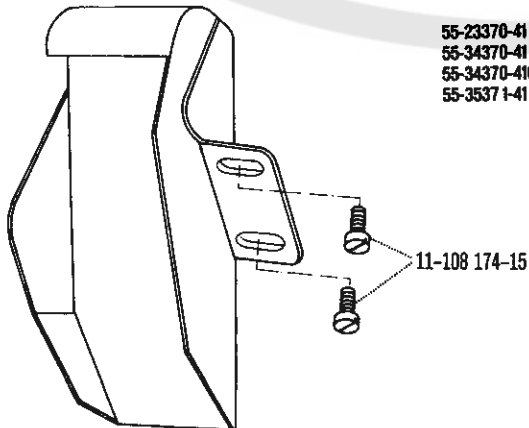

55-23370-41
 55-34370-41
 55-34370-410
 55-35371-41

96-707 139-15

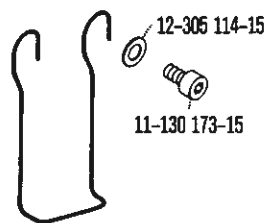

51-23300-01
 53-23 100-01
 53-23 100-02
 53-23300-01
 53-23300-011
 53-23300-02
 53-23500-020
 53-24301-01
 53-34300-01
 53-35303-01
 53-35303-02

55-23300-41
 55-23370-41
 55-23500-01
 55-23500-01
 55-23500-02
 55-23500-04
 55-23500-05
 55-23500-06
 55-34300-41
 55-34300-45
 55-34370-41
 55-34370-410

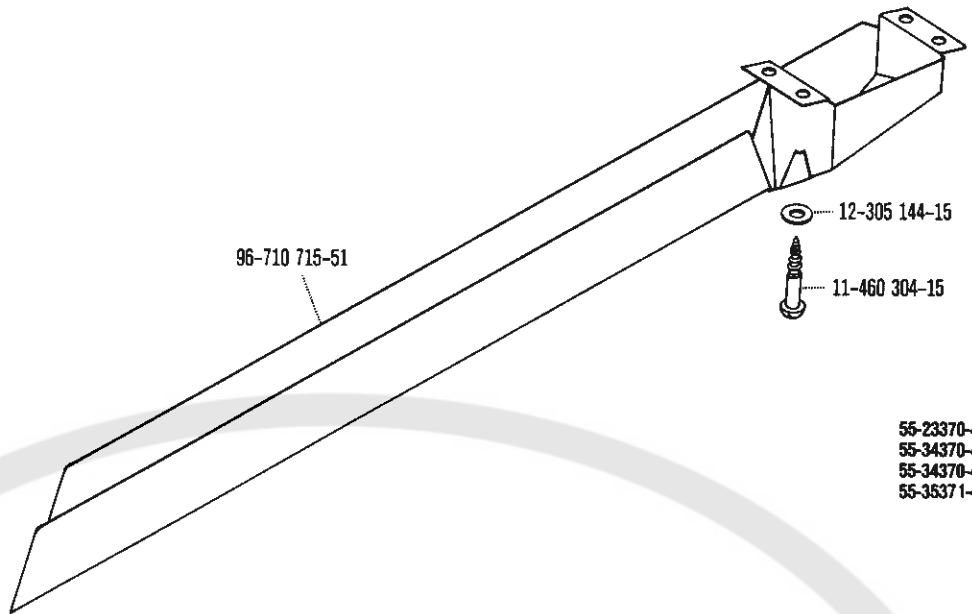

55-23370-41
 55-34370-41
 55-34370-410
 55-35371-41

96-707 287-91

55-34370-410

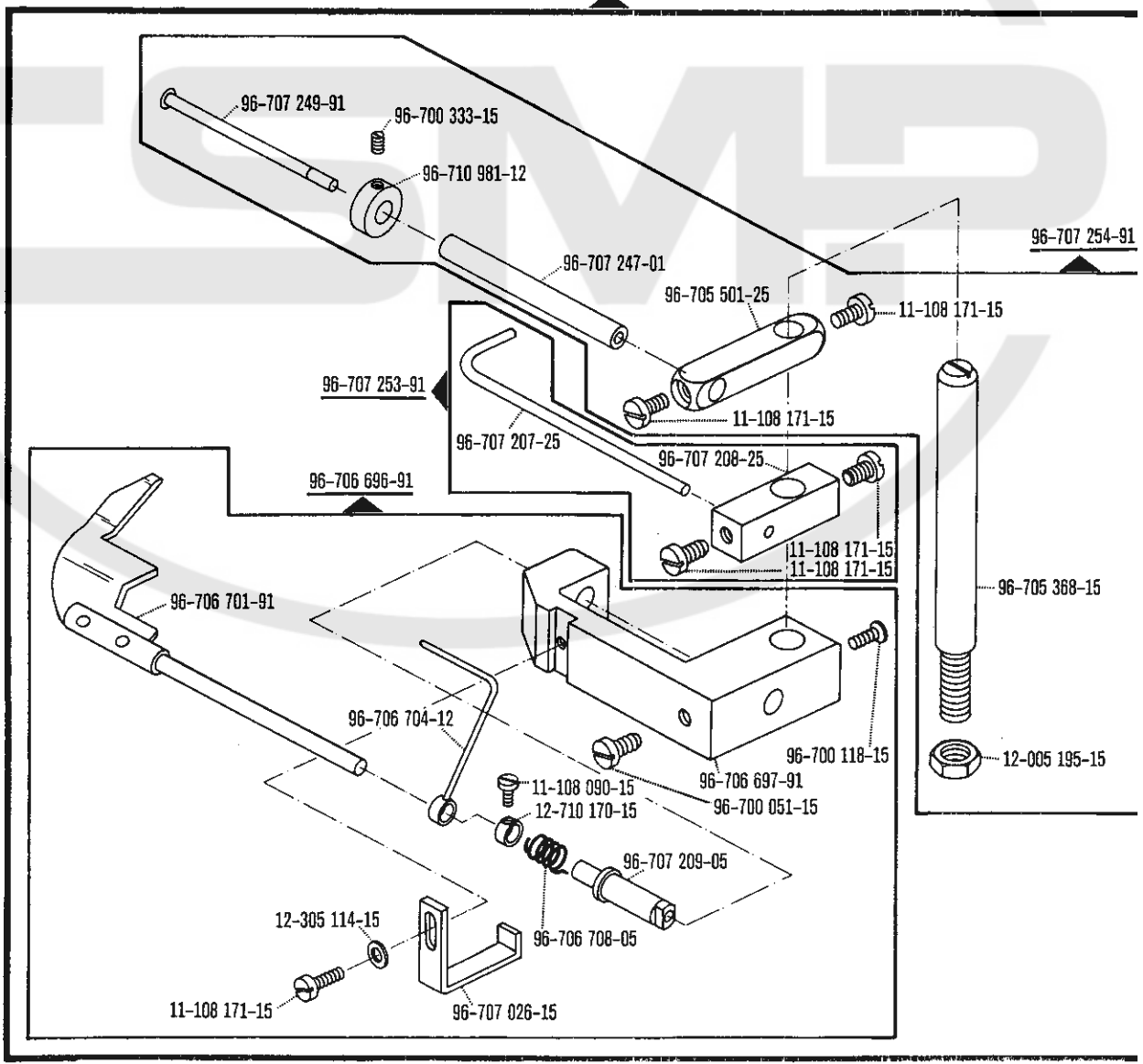

96-780 080-90

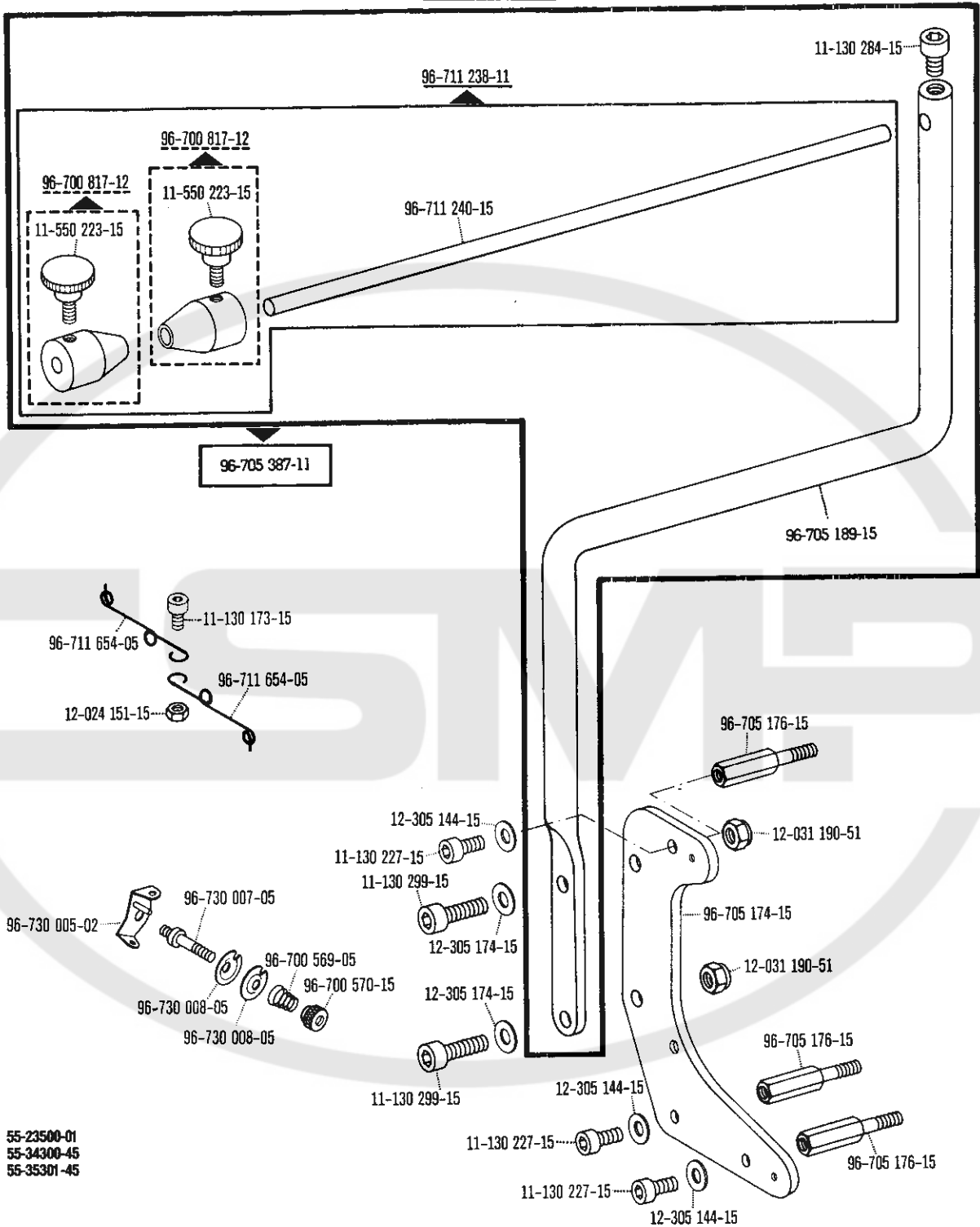

Pfaff, D 6750 Kaiserslautern, Postfach 3020/3040, Telex: 045 753