

FB-N310

パーツブック
PARTS BOOK

超高速安全縫ミシン

HIGH SPEED SAFETY STITCH SEWING MACHINE

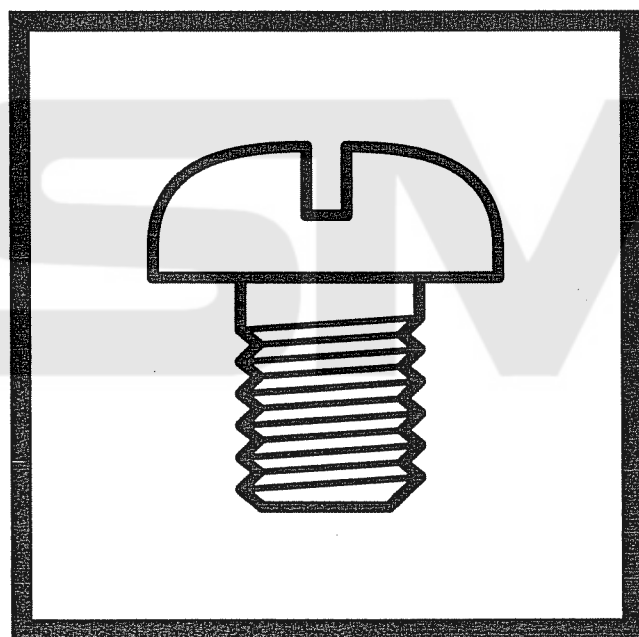

brother®



BROTHER INDUSTRIES, LTD. NAGOYA JAPAN

FB-N310- ①②③④-⑤⑥

仕様 / Specifications

装置 / Devices

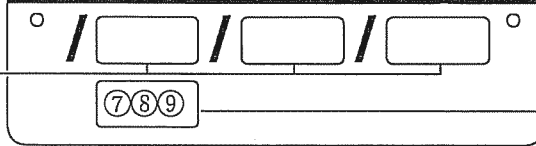

仕様明細 / Detail of specifications

①

	縫い目形式 / Stitch form
4	安全縫い・4本糸 / Safety stitch, 4-threads
5	安全縫い・5本糸 / Safety stitch, 5-threads
6	安全縫い・6本糸 / Safety stitch, 6-threads

⑥

	かがり幅 / Stitch width
2	2 mm
3	3 mm
4	4 mm
5	5 mm
6	6 mm
7	7 mm

②

	用途 / Applications
0	地縫い / Plain seaming
4	ひだ取り / Ruffling
5	テープ付け / Taping
6	パイピング付ひだ取り / Ruffling with piping
7	バイディングテープ付け / Binding with taping

⑦

	上ルーバリフト / Over-looper locus
S	スタンダード / Standard lift
H	ハイリフト / High lift
E	超ハイリフト / Extra high lift

③

	縫製物 / Sewing materials
1	極薄物～薄物 / Extra light - light materials
2	薄物～中厚物 / Light - medium materials
3	中厚物～厚物 / Medium - heavy materials
4	厚物～極厚物 / Heavy - Extra heavy materials
5	極厚物 / Extra heavy materials
6	バルキーニット / Bulky knit
7	極厚バルキーニット / Extra heavy bulky knit

⑧

	差動送り歯 / 針板チェーンランド / Differential feed dog
2	2列標準 / チェンランドあり 2-row standard / with chain land
3	3列標準 / チェンランドあり 3-row standard / with chain land

④

	特殊用途 / Special use
0	標準 / Standard
1	小回り仕様 / Small type
3	特殊作動比 / Special differential ratio

⑨

	上メス形状 / Upper knife shape
F	平メス / Flat knife
A	角メス / Angle knife
B	角メス幅広 / Angle knife, wide
V	角メス波刃 / Angle knife, wave shape
W	角メス幅広波刃 / Angle knife, wave shape

⑤

	針幅 / Needle gauge
2	2mm
3	3mm
5	5mm
A	3x2.2mm
B	5x2.2mm
C	5x3mm

パーツブックご利用に際して

1. この本は、2001年12月のデータに基づいて作成されたものです。
2. 部品は予告なしに設計変更される場合があります。
3. 組単位で補給する部品は、 破線で示してあります。
4. 部品コード欄が*となっている場合は、ゲージ部品一覧表(45~51ページ)でお調べ下さい。

目 次

A.	フレーム関係.	1
B.	駆動軸関係.	5
C.	針棒関係.	7
D.	針冷却関係.	9
E.	縁カガリ定規関係.	9
F1.	押工関係.	11
F2.	押工関係.	13
G.	送り関係.	15
H.	上メス・下メス関係.	19
J.	ラッパー関係.	21
K.	上ルーパ関係.	23
L.	下ルーパ関係.	25
M.	二重環ルーパー.	27
N.	給油潤滑関係.	29
P.	糸調子関係.	31
Q1.	ラフラー装置関係.	35
Q2.	ラフラー装置関係.	37
Q3.	ラフラー装置関係.	39
Z1.	付属品関係.	41
Z2.	付属品関係 (オプションパーツ)	43
Ga1.	ゲージ部品一覧表.	45
Ga2.	ゲージ部品一覧表.	46
Ga3.	ゲージ部品一覧表.	47
Ga4.	ゲージ部品一覧表.	48
Ga5.	ゲージ部品一覧表.	49
Ga6.	ゲージ部品一覧表.	50
Ga7.	ゲージ部品一覧表.	51
Wa.	警告ラベル	

Notes for using this parts book

1. This book was prepared based on information available in December 2001.
2. Parts are subject to changes in design without prior notice.
3. Parts supplied as complete assemblies are circled by a dotted line [].
4. If the symbol * is found in the " Parts No." column, refer to the gauge parts list on page 45~51.

CONTENTS

A.	Machine body.	1
B.	Crankshaft mechanism.	5
C.	Needle bar mechanism.	7
D.	Needle cooler.	9
E.	Serging attachment.	9
F 1.	Presser foot mechanism	11
F 2.	Presser foot mechanism	13
G.	Feed mechanism.	15
H.	Knife mechanism.	19
J.	Lapper mechanism.	21
K.	Over looper mechanism.	23
L.	Under looper mechanism.	25
M.	Double chain stitch looper mechanism.	27
N.	Lubrication.	29
P.	Thread tension.	31
Q1.	Ruffling attachment.	35
Q2.	Ruffling attachment.	37
Q3.	Ruffling attachment.	39
Z 1.	Accessories.	41
Z 2.	Accessories	43
G a1.	Gauge parts List.	45
G a2.	Gauge parts List.	46
G a3.	Gauge parts List.	47
G a4.	Gauge parts List.	48
G a5.	Gauge parts List.	49
G a6.	Gauge parts List.	50
G a7.	Gauge parts List.	51
Wa.	Warning labels	

A. フレーム関係 / Machine body

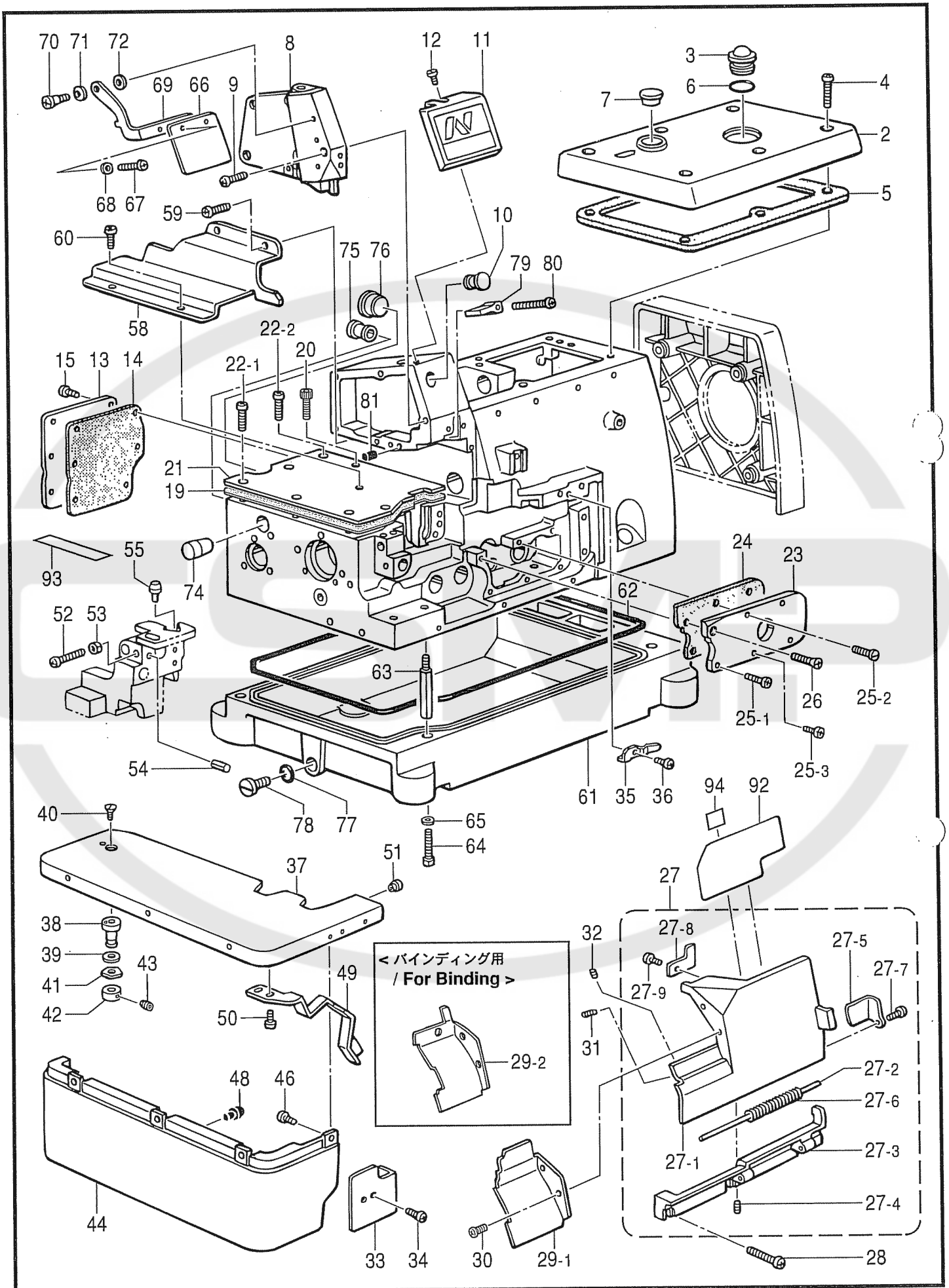

A. フレーム関係 / Machine body

REF.NO	CODE	Q'TY	ヒンメイ	NAME OF PARTS	RM
2	S39605001	1	ウツカハ-	TOP COVER	
3	S02606020	1	ユリヨウケイマト	OIL GAUGE WINDOW	
4	062401012	6	ナヘコM4X10	SCREW, PAN M4X10	
5	S39606020	1	ハツキン	PACKING	
6	081014670	1	OリングPW14	O RING, PW14	
7	S23337001	1	ゴムセン18.5	RUBBER CAP, 18.5	
8	S39607001	1	ツクメンカハ-	SIDE COVER, FRAME	
9	062400812	5	ナヘコ4X8	SCREW, PAN M4X8	
10	S20345001	1	ゴムセン14	RUBBER CAP, 14	
11	S39608021	1	メンイタカハ-	FACE PLATE COVER	
12	060400612	1	ハイントM4X6	SCREW, BIND M4X6	
13	S20310001	1	オクリキコウカハ-B	COVER, B ;FEED MECHANISM	
14	S20311000	1	ハツキン	PACKING	
15	060400812	6	ハイントM4X8	SCREW, BIND M4X8	
19	S44778000	1	オクリタイカハ-ハツキン	PACKING, FEED BAR	
20	018400832	1	アナホルト4X8	BOLT, SOCKET M4X8	
21	S44779001	1	オクリタイカハ-	FEED BAR COVER	
22-1	060400812	5	ハイントM4X8	SCREW, BIND M4X8	
22-2	S44535001	1	ハイントM4X8シール	SCREW, BIND M4X8 SEAL	
3	S39564021	1	ウチカハ-	INSIDE COVER	
4	S44536000	1	ウチカハ-ハツキン	PACKING, INSIDE COVER	
25-1	060401012	3	ハイントM4X10	SCREW, BIND M4X10	
25-2	S23616101	1	シメネジ4X10	SCREW, M4X10	
25-3	S44535001	1	ハイントM4X8シール	SCREW, BIND M4X8 SEAL	
26	061400812	1	サラコM4X8	SCREW, FLAT M4X8	
27	S39611001	1	マイカハ-Lクミ	FRONT COVER ASSY, L	
27-1	S39612001	1	マイカハ-L	FRONT COVER, L	
27-2	S39613001	1	マイカハ-ヒンジシク	HINGE SHAFT, FRONT COVER	
27-3	S20319001	1	マイカハ-ヒンジ	HINGE, FRONT COVER	
27-4	012400432	2	アナヒラ4X4	SET SCREW, SOCKET (FT) M4X4	
27-5	S20320101	1	マイカハ-ストツハ	STOPPER, FRONT COVER	
27-6	S20321001	1	マイカハ-ハネ	SPRING, FRONT COVER	
27-7	060400612	1	ハイントM4X6	SCREW, BIND M4X6	
27-8	S20327101	1	マイカハ-トメイタ	STOPPER PLATE, FRONT COVER	
27-9	060400612	1	ハイントM4X6	SCREW, BIND M4X6	
28	060401412	3	ハイントM4X14	SCREW, BIND M4X14	
29-1	S38305001	1	マイカハ-S	FRONT COVER, S	
29-2	S42050001	1	<ハイントイック用> マイカハ-S	<For Binding> FRONT COVER, S	
30	062400612	2	ナヘコM4X6	SCREW, PAN M4X6	
31	012400832	1	アナヒラ4X8	SET SCREW, SOCKET (FT) M4X8	
32	012400432	1	アナヒラ4X4	SET SCREW, SOCKET (FT) M4X4	
33	S20324101	1	マイカハ-Lアソナイ	GUIDE, L F-VOVER	
34	060400612	2	ハイントM4X6	SCREW, BIND M4X6	
35	S20325001	1	マイカハ-トメイタハネ	SPRING, PLATE	
36	060400612	1	ハイントM4X6	SCREW, BIND M4X6	
37	S39562001	1	クロスプレート	CLOTH PLATE	
38	S39623001	1	クロスプレートサエシク	CLOTH PLATE SHAFT	
39	141183000	1	クロスプレートシート	CLOTH PLATE SHEET	
40	100032003	1	サラネジ4.37	SCREW, FLAT SM4.37-40X8	
41	100315002	1	ナミハネ	WASHER	
42	S39624021	1	セツトカラー	SET SCREW COLLAR	
43	012060632	2	アナヒラ6X6	SET SCREW, SOCKET (FT) M6X6	
44	S38301020	1	クロスプレートシタ	CLOTH PLATE, LOWER	
46	060400612	4	ハイントM4X6	SCREW, BIND M4X6	
48	S20412000	2	ゴムセン3.7	RUBBER CAP, 3.7	
49	S39625151	1	クロスプレートトメイタハネ	SPRING, PLATE	
50	060400612	2	ハイントM4X6	SCREW, BIND M4X6	

A. フレーム関係 / Machine body

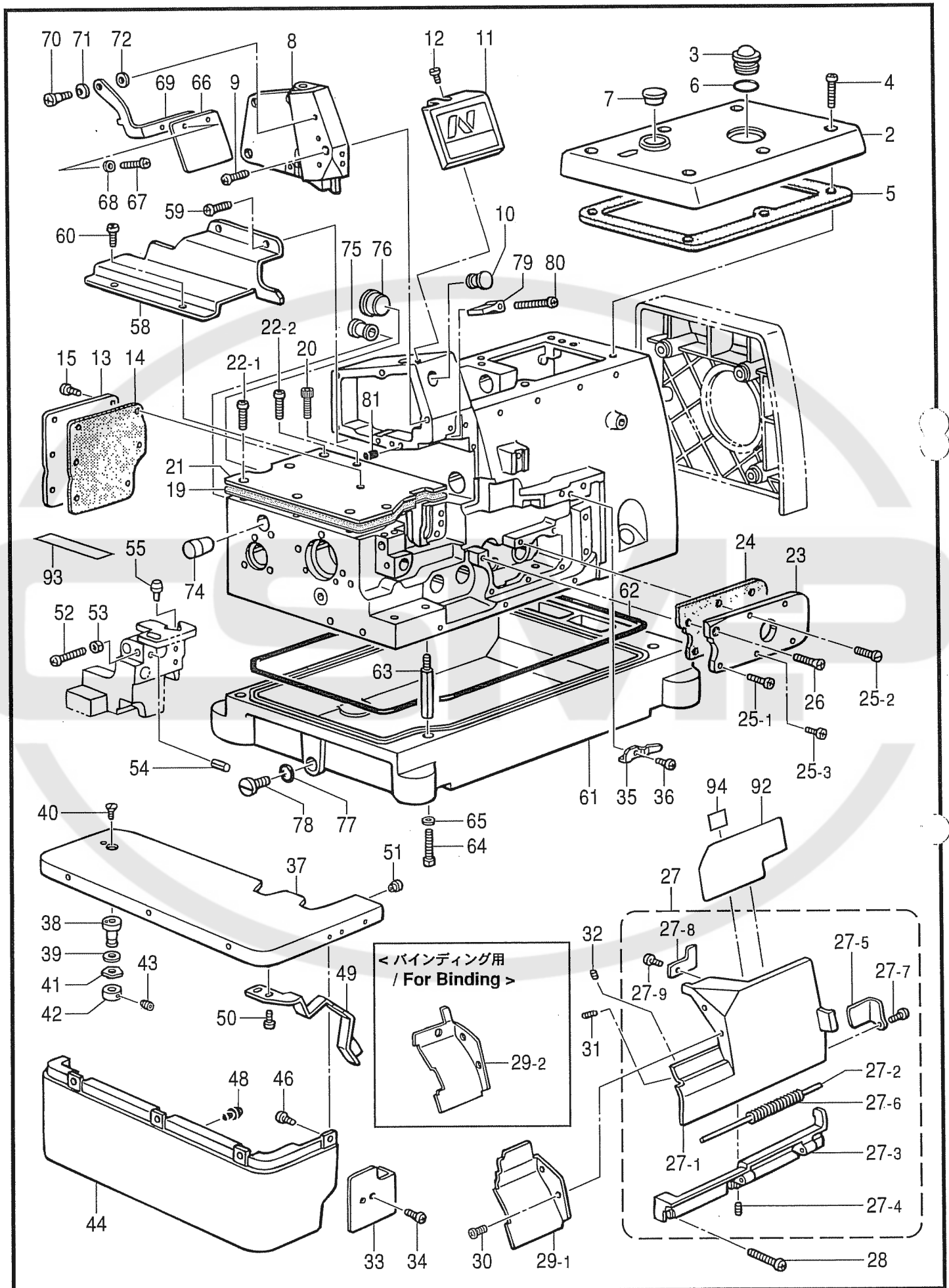

A. フレーム関係 / Machine body

REF.NO	CODE	Q'TY	ヒンメイ	NAME OF PARTS	RM
51	156482000	1	セン4	CAP, 4	
52	062401212	1	ナヘコ4X12	SCREW, PAN M4X12	
53	021400212	1	2シユナツ4	NUT, 2 M4	
54	047602042	1	スプリングピン6X20	PIN, SPRING ROLL 6X10	
55	S20412000	1	ゴムセン3.7	RUBBER CAP, 3.7	
58	S39626021	1	クロスプレートヌメアンナイ	CLOTH GUIDE	
59	060400612	2	ハインドM4X6	SCREW, BIND M4X6	
60	060400512	1	ハインドM4X5	SCREW, BIND M4X5	
61	S20338200	1	アブラウケ	OIL PAN	
62	S20339000	1	ハツキン	PACKING	
63	S23350001	4	ホンタイシユウ	MACHINE BODY LEG	
64	017501212	4	ホルルト5X12	BOLT, M5X12	
65	S23351001	4	サカネ	WASHER	
66	S00075000	1	アイガード	EYE GUARD	
67	060350812	2	ハインドM3.5X8	SCREW, BIND M3.5X8	
68	025350332	2	ヒラサカネ13.5	WASHER, PLAIN L 3.5	
69	S20340001	1	アイガードサエタ	EYE GUARD SUPPORT PLATE	
70	S20342001	1	タンネジ4	SHOULDER SCREW, M4	
71	146598001	1	ハネサカネ	WASHER, BOWL SPRING	
72	025050132	1	ヒラサカネヨウ5	WASHER, PLAIN S 5	
74	S20344001	1	ゴムセン16	RUBBER CAP, 16	
75	S20345001	1	ゴムセン14	RUBBER CAP, 14	
76	S23337001	1	ゴムセン18.5	RUBBER CAP, 18.5	
77	081009070	1	リングP9	O RING P9	
78	S23357001	1	シメネジ10	SCREW, M10	
79	S20346000	1	ハリホウアブラウケ	OIL RESERVOIR, N-BAR	
80	062401612	1	ナヘコM4X16	SCREW, PAN M4X16	
81	S20878000	1	ゴムセン5.3	RUBBER CAP, 5.3	
92	S39785001	1	<5本系用> イトオシセツメイラベルD	<For "5 Threads"> THREADING DIAGRAM LABEL, D	
92	S39786001	1	<4本系用> イトオシセツメイラベルE	<For "4 Threads"> THREADING DIAGRAM LABEL, E	
92	S39787001	1	<6本系用> イトオシセツメイラベルF	<For "6 Threads"> THREADING DIAGRAM LABEL, F	
93	S25184001	1	DLイトオシセツメイラベル	THREADING DIAGRAM LABEL, DL	
94	S44821001	1	セイソウシラベル	LABEL,CLEANING	

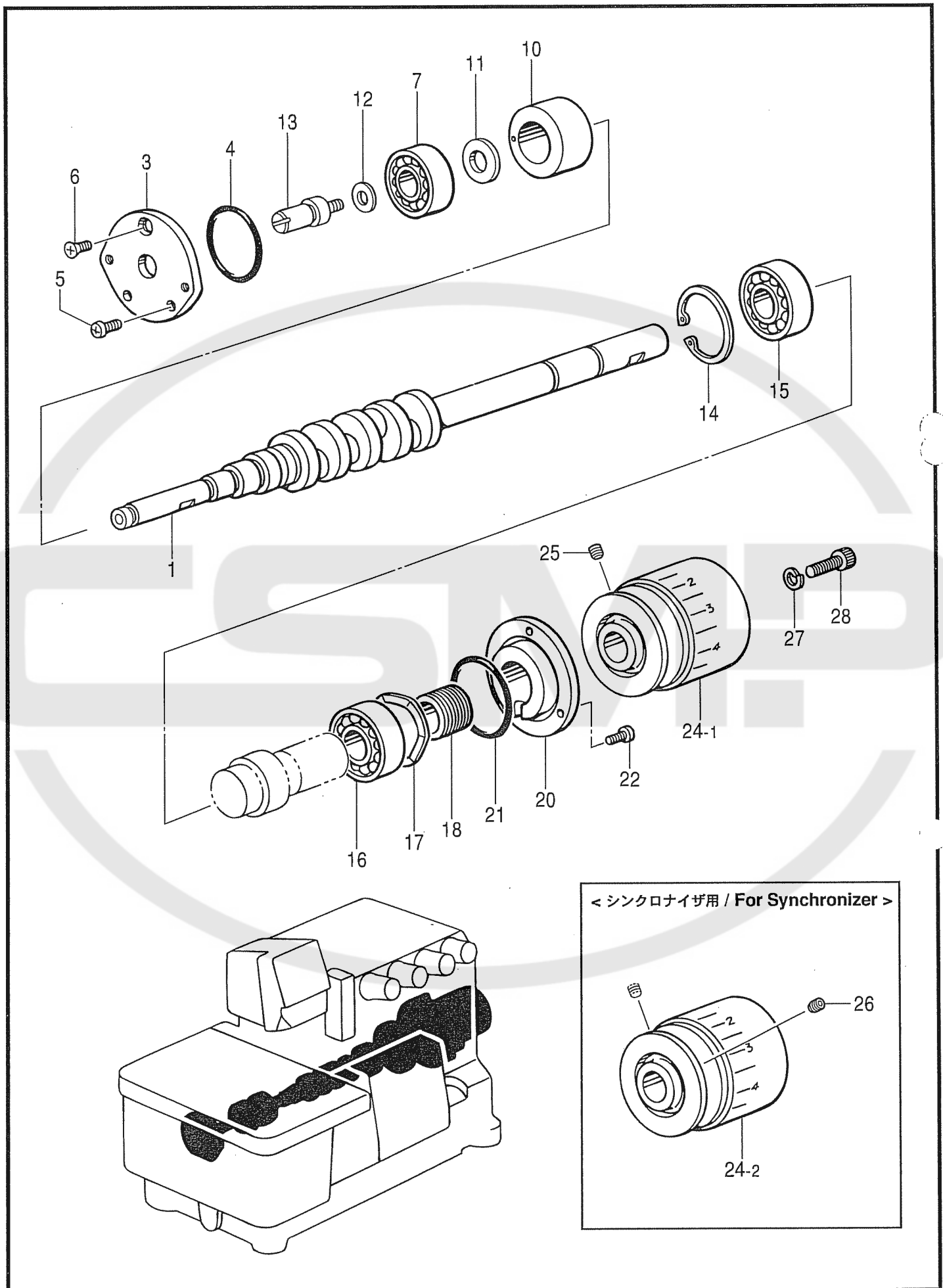

B. 駆動軸関係 / Crankshaft mechanism

REF.NO	CODE	Q'TY	ヒンメイ	NAME OF PARTS	RM
1	S54001001	1	<スタンダード、ハイリフト用> クランク	<For Standard & High lift> CRANKSHAFT, R	
1	S54002001	1	<超ハイリフト用> クランクS	<For Extra High lift> CRANKSHAFT,S	
3	S39629021	1	ベアリングフタ	BEARING CAP	
4	081031870	1	Oリング S31.5	O RING, S31.5	
5	062400812	2	ナットM4X8	SCREW, PAN M4X8	
6	061400812	1	フラットM4X8	SCREW, FLAT M4X8	
7	072600000	1	ボールベアリング6000	BALL BEARING, 6000	
10	S39630000	1	クランクメタル	BUSH, CRANKSHAFT	
11	S20356001	1	ワッシャー 10	WASHER, PLAIN 10	
12	155559001	1	ワッシャー	WASHER, PLAIN	
13	S46900001	1	シフトカムシャフト	SHAFT, D/C STITCH THR/TAKE-UP	
14	048400242	1	リテーニングリングC40	RETAINING RING, INTERNAL C40	
15	076203000	1	ボールベアリング6203	BALL BEARING, 6203	
16	S27868001	1	ボールベアリング6203V	BALL BEARING, 6203V	
17	S20361001	1	バネ	SPRING, WAVE	
18	S20362151	1	クランクオイルキリ	OIL REJECTOR, CRANKSHAFT	
19	S39631000	1	ベアリングホルダ	HOLDER, BEARING	
21	S20353000	1	Oリング	O RING	
22	062401012	3	ナットM4X10	SCREW, PAN M4X10	
24-1	S39775001	1	プーリ	PULLEY	
24-2	S39565101	1	<シンクロナイザ用> プーリ	<For Synchronizer> PULLEY	
26	012060632	1	ナットM6X6	SET SCREW, SOCKET (FT) M6X6	
25	012060632	1	ナットM6X6	SET SCREW, SOCKET (FT) M6X6	
27	028060242	1	ワッシャー 2-6	WASHER, SPRING 2-6	
28	018062532	1	ボルトM6X25	BOLT, SOCKET M6X25	

C. 針棒關係 / Needle bar mechanism

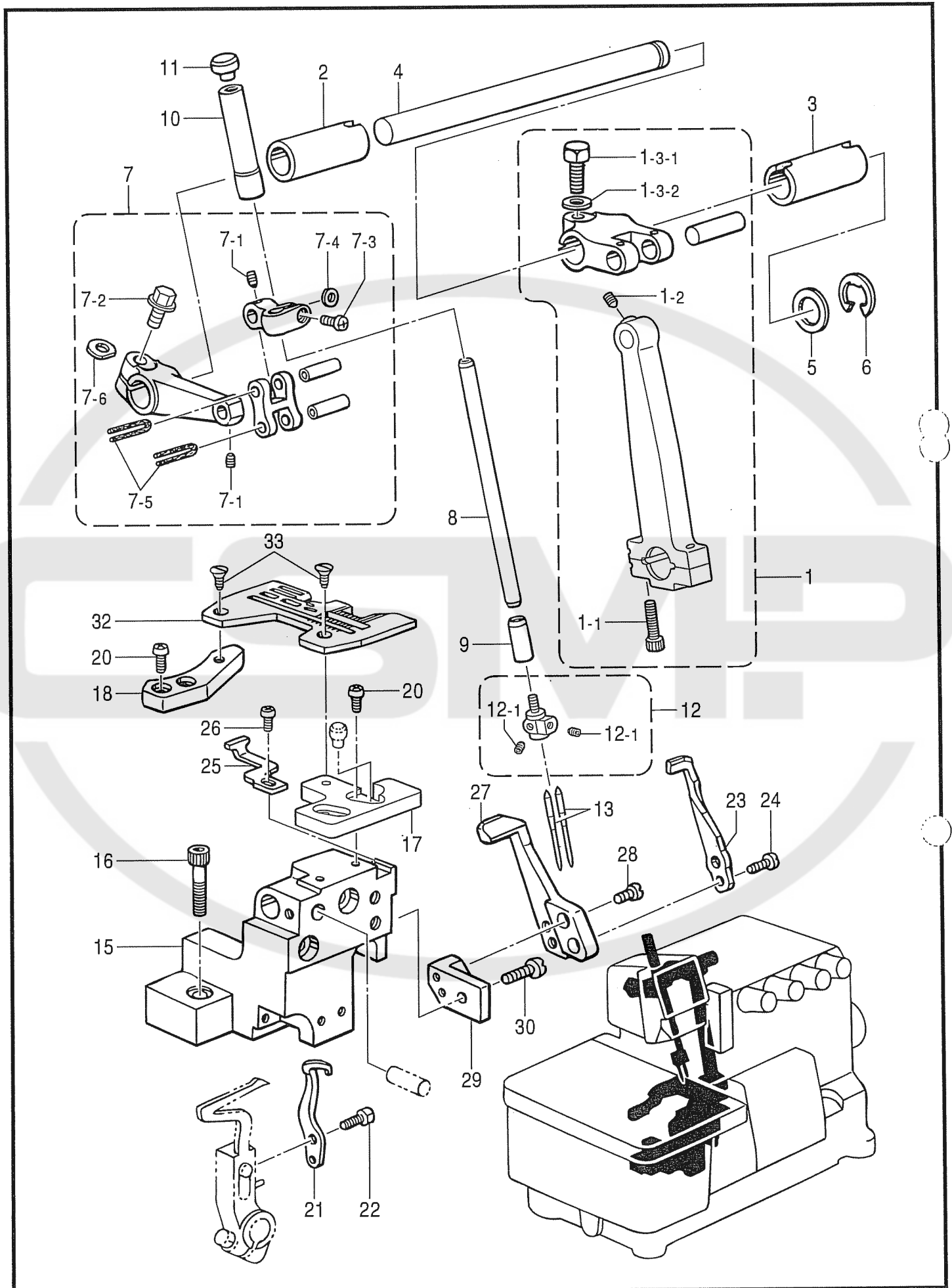

C. 針棒関係 / Needle bar mechanism

REF.NO	CODE	Q'TY	ヒンメイ	NAME OF PARTS	RM
1	S54003001	1	<スタンダード、ハイリフト用> ハリクランクロッドクミS	<For Standard lift> NEEDLE D/CRANK ROD ASSY, S	
1	S54006001	1	<スタンダード、ハイリフト用> ハリクランクロッドクミH	<For High lift> NEEDLE D/CRANK ROD ASSY, H	
1	S54007001	1	<超ハイリフト用> ハリクランクロッドクミE	<For Extra High lift> NEEDLE D/CRANK ROD ASSY, E	
1-1	018401622	2	アナボルト4X16	BOLT, SOCKET M4X16	
1-2	S23342001	1	アトガリ4X5	SET SCREW, SOCKET (CN) M4X5	
1-3-1	017061612	1	ボルト6X16	BOLT, M6X16	
1-3-2	118735002	1	ワッシャ	WASHER, PLAIN	
2	S39644021	1	ハリシクメタルL	BUSH, L ;NEEDLE SHAFT	
3	S39645021	1	ハリシクメタルR	BUSH, R ;NEEDLE SHAFT	
4	S39646021	1	ハリシク	NEEDLE SHAFT	
5	S39647000	1	ワッシャ	WASHER	
6	146293001	1	トメワE10	RETAINING RING, E10	
7	S39566001	1	ハリボウダキミ	NEEDLE BAR CLAMP ASSY	
7-1	S23342001	2	アトガリ4X5	SET SCREW, SOCKET (CN) M4X5	
7-2	S46899001	1	ワッシャキボルト6X16	BOLT, (W/WASHER) M6X16	
7-3	062350812	1	ナット3.5X8	SCREW, PAN M3.5X8	
7-4	S20391001	1	スペーサ	SPACER	
7-5	S20392000	2	フェルト	FELT	
7-6	155162001	1	スペーサ	SPACER	
8	S39574001	1	ハリボウ	NEEDLE BAR	
9	S39648021	1	ハリボウメタルD	BUSH, D ;NEEDLE BAR	
10	S39571021	1	ハリボウメタルU	BUSH, U ;NEEDLE BAR	
11	104450101	1	ゴムセン8	RUBBER CAP, 8	
12	*	1	ハリトメクミ	NEEDLE CLAMP ASSY	
12-1	146427001	2	アトメネジ 3.18クボミ	SET SCREW, SOCKET (CP) SM3.18	
13	*	2	ミシンハリDCX27	NEEDLE, DCX27	
15	S39649021	1	ハリイタササエタイ	SUPPORT BRACKET, N-PLATE	
16	018062532	2	アナボルト6X25	BOLT, SOCKET M6X25	
17	S39650051	1	ハリイタササエタイF	NEEDLE PLATE SUPPORT, F	
18	S39652021	1	ハリイタササエタイB	NEEDLE PLATE SUPPORT, B	
20	062401012	4	ナットM4X10	SCREW, PAN M4X10	
21	S20415101	1	イトウハリウケ	NEEDLE GUARD, MOVABLE	
22	S20416101	1	ボルト3.5X10	BOLT, M3.5X10	
23	S20418051	1	オーハハリウケF	NEEDLE GUARD, F	
24	S23456101	2	ナット25X6	SCREW, PAN M2.5X6	
25	S38306051	1	ニシユウカンハリウケF	D-CHAIN STITCH N/GUARD, F	
26	062350812	1	ナット3.5X8	SCREW, PAN M3.5X8	
27	S38307001	1	ニシユウカンハリウケB	D-CHAIN STITCH N/GUARD, B	
28	062300812	2	ナット3X8	SCREW, PAN M3X8	
29	S39654051	1	ハリウケブラケット	NEEDLE GUARD BRACKET	
30	062401012	1	ナットM4X10	SCREW, PAN M4X10	
32	*	1	ハリイタ	NEEDLE PLATE	
33	100032003	2	ワッシャ 4.37	SCREW, FLAT SM4.37-40X8	

D. 針冷却関係 / Needle cooler

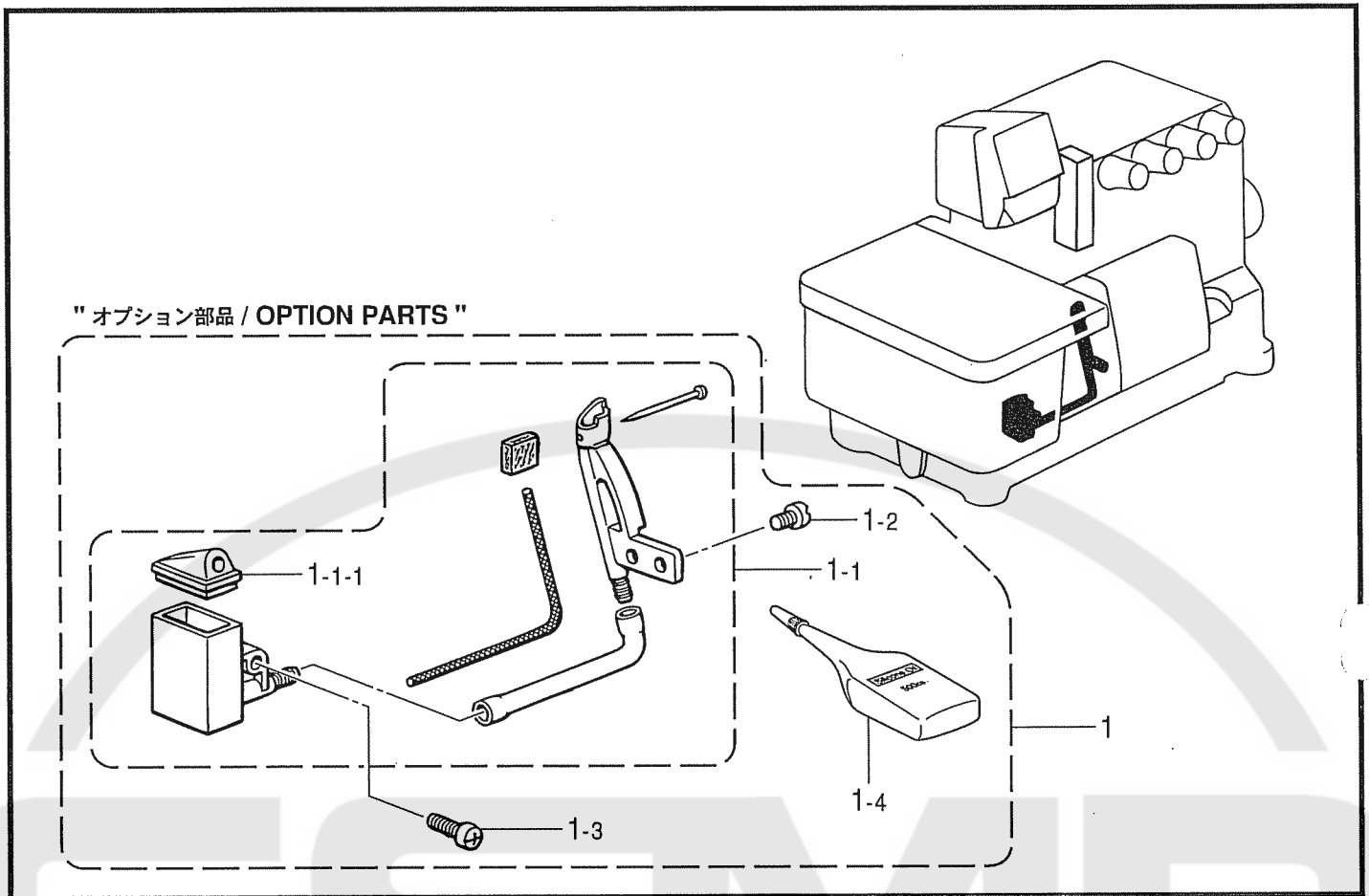

878-N31-124

E. 縁カガリ定規関係 / Serging attachment

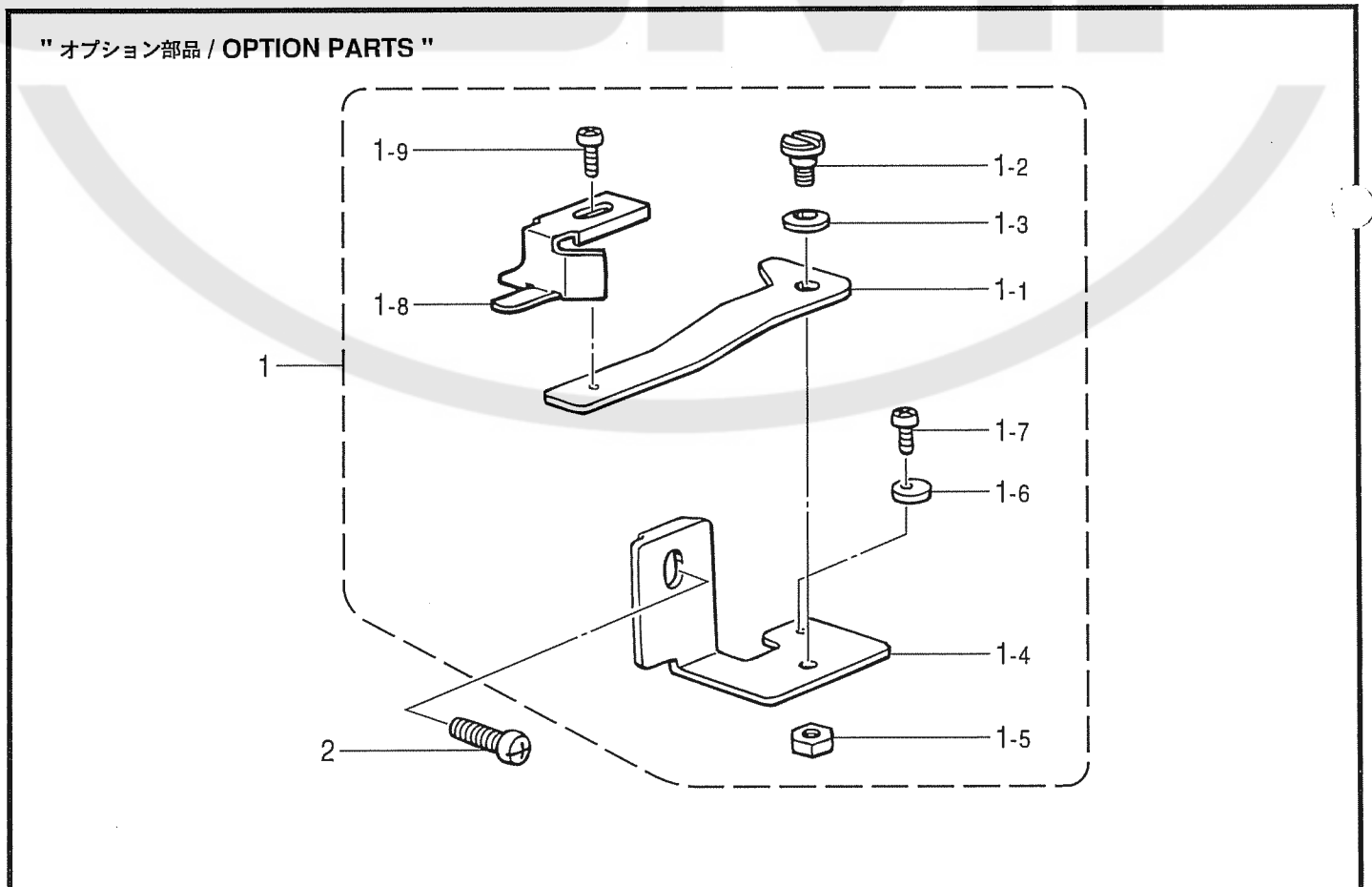

D. 針冷却関係 / Needle cooler

REF.NO	CODE	Q'TY	ヒンメイ	NAME OF PARTS	RM
1	S43525001	1	” オプション部品” ハリレキヤセットS	"OPTION PARTS" NEEDLE COOLER SET, S	
1-1	S20468001	1	フェルトサエクミ	FELT SUPPORT ASSY	
1-1-1	S20460000	1	シリコンタンクフタ	CAP, SILICONE TANK	
1-2	S23418002	2	シメネジ 4X5	SCREW, M4X5	
1-3	060401012	1	バインド M4X10	SCREW, BIND M4X10	
1-4	S06704001	1	シリコンオイル	SILICONE OIL	

878-N31-124

E. 縁カガリ定規関係 / Serging attachment

REF.NO	CODE	Q'TY	ヒンメイ	NAME OF PARTS	RM
1	S32140001	1	” オプション部品” フチカガリシヨウキクミ	"OPTION PARTS" EDGE GUIDE ASSY	
1-1	S23896101	1	シヨウキトリツケイタ	SETTING PLATE, ;EDGE GUIDE	
1-2	S23773001	1	タンネジ 4	SHOULDER SCREW, M4	
1-3	146598001	1	ハネサガネ	WASHER, BOWL SPRING	
1-4	S23897001	1	シヨウキトリツケイタササエ	EDGE GUIDE SUPPORT	
-5	021400212	1	2シユナツト4	NUT, 2 M4	
1-6	S21341001	1	ストッパ-	STOPPER	
1-7	062300512	1	ナハ 3X5	SCREW, PAN M3X5	
1-8	146600001	1	フチカガリシヨウキ	EDGE GUIDE	
1-9	062350612	1	ナハ 3M3.5X6	SCREW, PAN M3.5X6	
2	062401012	1	ナハ 3M4X10	SCREW, PAN M4X10	

878-N31-236

F1 . 押工関係 / Presser foot mechanism

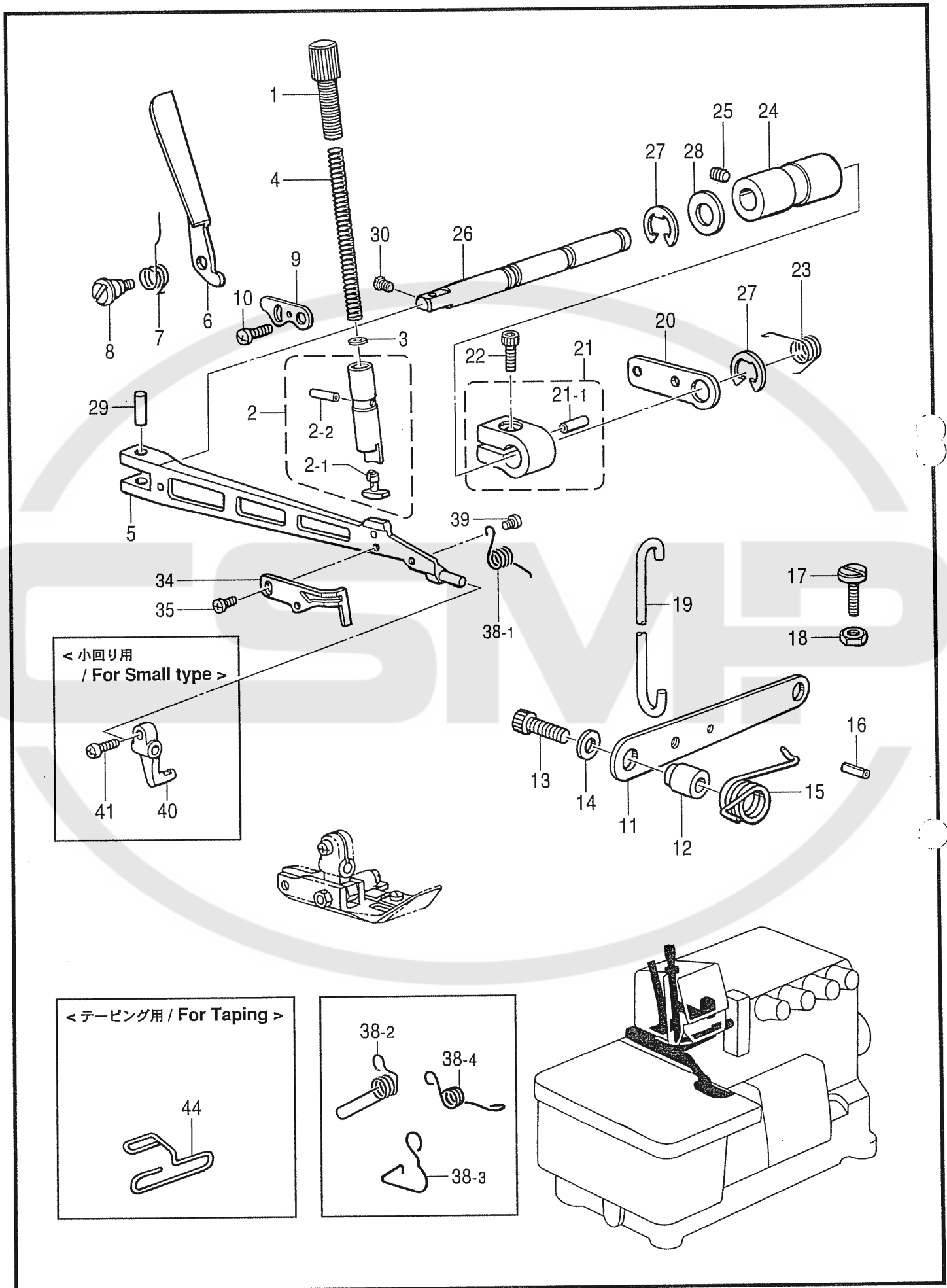

F1. 押工関係 / Presser foot mechanism

REF.NO	CODE	QTY	ヒンメイ	NAME OF PARTS	RM
1	S39658001	1	オサエチヨウセツネジ	ADJUSTING SCREW, PRESSER	
2	S39575001	1	オサエホウクミ	PRESSER BAR ASSY	
2-1	S39577000	1	オサエクツシヨシ	CUSHION	
2-2	047301642	1	スプリングピンAW3	SPRING PIN AW3	
3	105161004	1	サカネ	WASHER, PLAIN	
4	S20476001	1	オサエハネ	PRESSER SPRING	
5	S38308121	1	シユオサエウテ	MAIN PRESSER ARM	
6	S39659021	1	オサエテアケ	PRESSER BAR LIFTER	
7	S39660001	1	オサエテアケハネ	SPRING, PRESSER BAR LIFTER	
8	S39661001	1	タネネジ4	SHOULDER SCREW, M4	
9	S39662001	1	シユオサエウテストップ	MAIN PRESSER ARM STOPPER	
10	060400612	1	ハイントM4X6	SCREW, BIND M4X6	
11	S39663121	1	オサエアシアケレバー	PRESSER FOOT LIFTER LEVER	
12	S39664101	1	オサエアシアケレバーカラー	COLLAR	
13	018062532	1	アナホルト6X25	BOLT, SOCKET M6X25	
14	025060332	1	ヒラサカネタ16	WASHER, PLAIN L 6	
15	S39665001	1	オサエアシアケレバーハネ	SPRING	
16	047502542	1	スプリングピンAW5	PIN, SPRING ROLL AW5	
17	S39770001	1	シメネジ4	SCREW, M4	
18	021400212	1	2シユナツト4	NUT, 2 M4	
19	S20485001	1	オサエアケリンク	PRESSER BAR LIFTER LINK	
20	S39666001	1	オサエアケレバー	LIFTER LEVER, ;P-BAR	
21	S39667021	1	オサエアケウテクミ	LIFTER ARM ASSY, ;P-BAR	
21-1	047401442	1	スプリングピンAW4	PIN, DOWEL ;AW4	
22	018061632	1	アナホルト6X16	BOLT, SOCKET M6X16	
23	S39669101	1	オサエアケレバーハネ	SPRING	
24	S39670000	1	オサエウテシクメタル	BUSH, ;P-ARM SHAFT	
25	012060632	1	アナヒラ6X6	SET SCREW, SOCKET (FT) M6X6	
26	S39671121	1	オサエウテシク	PRESSER ARM SHAFT	
27	048090342	2	トメワE9	RETAINING RING, E9	
28	S30562000	1	サカネ	WASHER	
29	S39672001	1	オサエウテピン	PIN, ;P-ARM	
30	S46903001	1	アタマツキトメネジ4X5	SET SCREW, M4X5	
34	S37070121	1	フィンガードV	FINGER GUARD, V	
35	060300412	1	ハイントM3X4	SCREW, BIND M3X4	
38-1	S44744001	1	オサエネジリハネ	SPRING, TWIST	
38-2	S20115001	1	<デニム用> オサエネジリハネ	<For Denim> SPRING, TWIST	
38-3	S20117001	1	<デニムタテポケット用> オサエネジリハネ	<For Denim vertical pocket> SPRING, TWIST	
38-4	S30889001	1	<小回り用> オサエネジリハネ	<For Small type> SPRING, TWIST	
39	060300612	1	ハイント M3X6	SCREW, BIND M3X6	
40	S30888001	1	<小回り用> サブオサエウテ	<For Small type> SUB PRESSER ARM	
41	062670712	1	ナハコ357-40X7	SCREW, PAN SM3.57-40X7	
44	S23364000	1	<テーピング用> テープ案内	<For Taping> TAPE GUIDE	

4020
4030
4420
4430
4720
5020
5030
5420
5430
5720
6030
6430

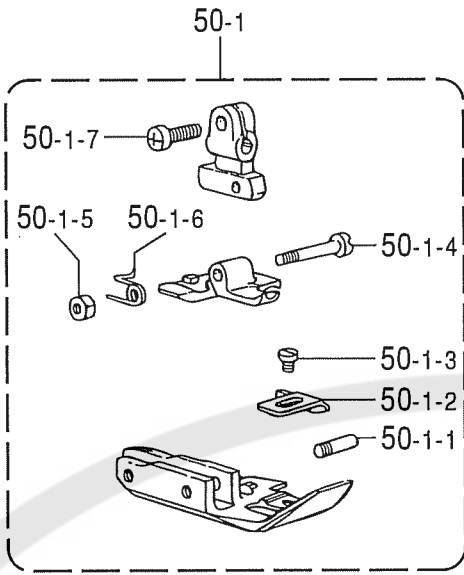

4050
5050

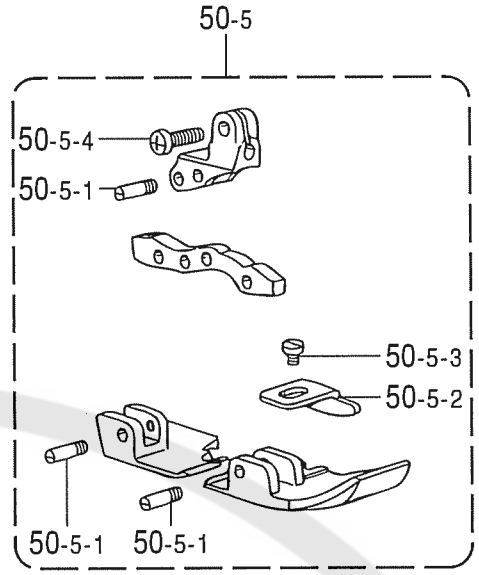

4010
4520
4530
5010
5520
5530

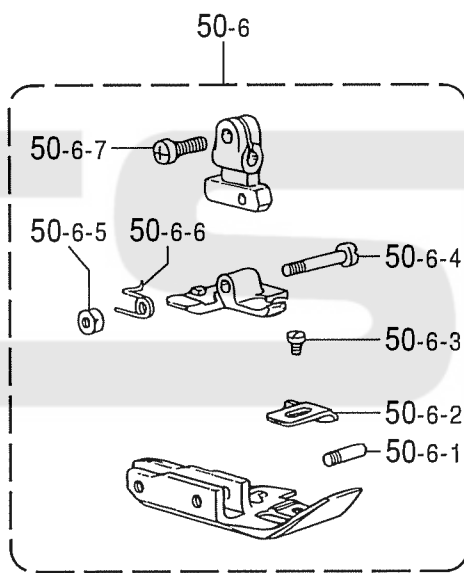

4620
4630
5620
5630

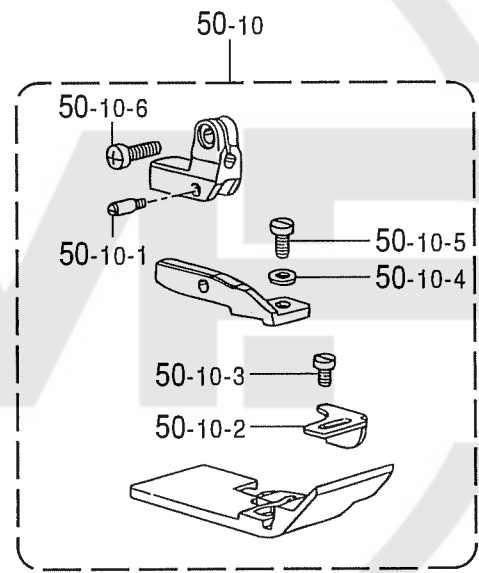

5051

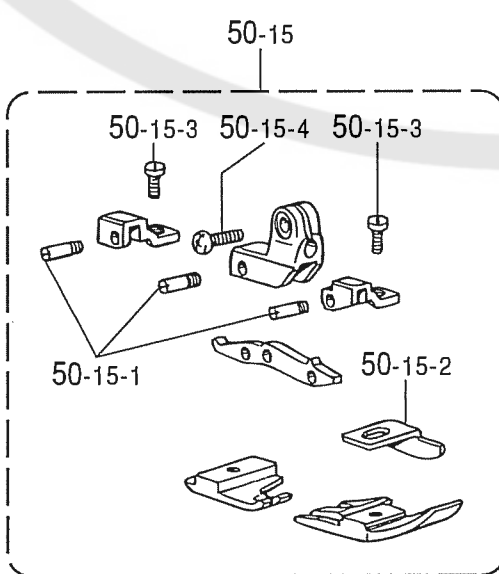

< 小回り用 / For Small type >

5010
5020

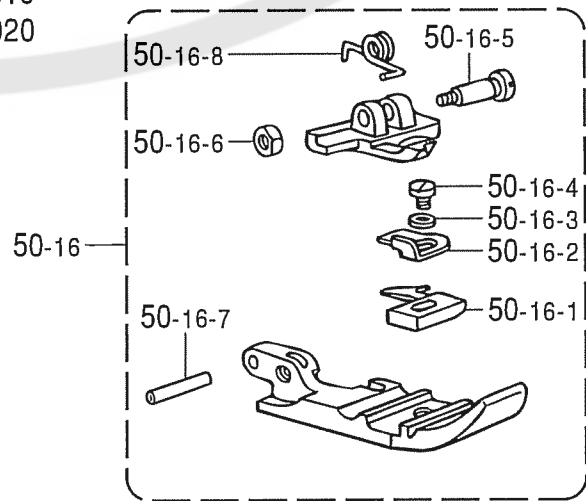

F2. 押工関係 / Presser foot mechanism

REF.NO	CODE	Q'TY	品名	NAME OF PARTS	RM
50-1	*	1	<4020,4030,4420,4430,4720 5020,5030,5420,5430,5720 6030,6430> オサイクミ	PRESSER FOOT ASSY	
50-1-1	S19311101	1	オサエサエネジ	SCREW	
50-1-2	*	1	オサIF	PRESSER FOOT, F	
50-1-3	105288001	1	シメネジ 2.38	SCREW, SM2.38	
50-1-4	S19307001	1	オサIBサエネジ	SCREW	
50-1-5	S19308001	1	2シユナツト318-44	NUT, 2 SM3.18-44	
50-1-6	S19309001	1	オサIBネジリハネ	SPRING, TWIST	
50-1-7	062670712	1	ナハコ357-40X7	SCREW, PAN SM3.57-40X7	
50-5	*	1	<4050,5050> オサイクミ	PRESSER FOOT ASSY	
50-5-1	S19311101	3	オサエサエネジ	SCREW	
50-5-2	*	1	オサIF	PRESSER FOOT, F	
50-5-3	106640001	1	シメネジ 3.18	SCREW, SM3.18	
50-5-4	062670712	1	ナハコ357-40X7	SCREW, PAN SM3.57-40X7	
50-6	*	1	<4010,4520,4530,5010,5520 5530> オサイクミ	PRESSER FOOT ASSY	
50-6-1	S19311101	1	オサエサエネジ	SCREW	
50-6-2	*	1	オサIF	PRESSER FOOT, F	
50-6-3	140530002	1	シメネジ 2.38	SCREW, SM2.38	
50-6-4	S19307001	1	オサIBサエネジ	SCREW	
50-6-5	S19308001	1	2シユナツト318-44	NUT, 2 SM3.18-44	
50-6-6	S19309001	1	オサIBネジリハネ	SPRING, TWIST	
50-6-7	062670712	1	ナハコ357-40X7	SCREW, PAN SM3.57-40X7	
50-10	*	1	<4620,4630,5620,5630> オサイクミ	PRESSER FOOT ASSY	
50-10-1	S19311101	1	オサエサエネジ	SCREW	
50-10-2	*	1	オサIF	PRESSER FOOT, F	
50-10-3	105288001	1	シメネジ 2.38	SCREW, SM2.38	
50-10-4	025660132	1	ヒラサカネシヨウ3.18	WASHER, PLAIN S 3.18	
50-10-5	106640001	1	シメネジ 3.18	SCREW, SM3.18	
50-10-6	062670712	1	ナハコ357-40X7	SCREW, PAN SM3.57-40X7	
50-15	*	1	<5051> オサイクミ	PRESSER FOOT ASSY	
50-15-1	S19311101	3	オサエサエネジ	SCREW	
50-15-2	*	1	オサIF	PRESSER FOOT, F	
50-15-3	100080004	2	シメネジ 3.18	SCREW, SM3.18-44X6.5	
50-15-4	062670712	1	ナハコ357-40X7	SCREW, PAN SM3.57-40X7	
50-16	*	1	<5010,5020> オサイクミ	<5010,5020 For Small type> PRESSER FOOT ASSY	
50-16-1	*	1	ツメ	STITCH TONGUE	
50-16-2	S19368001	1	オサイトリツケイタ	PRESSER FOOT PLATE	
50-16-3	025030132	1	ヒラサカネシヨウ3	WASHER, PLAIN S 3	
50-16-4	150755001	1	シメネジ 3.18	SCREW, SM3.18	
50-16-5	S30590001	1	オサIBサエネジ	SUPPORT SCREW	
50-16-6	500296002	1	ナツト	NUT	
50-16-7	047161042	1	スプリングピンAW1.6	PIN, SPRING ROLL AW1.6	
50-16-8	S53955001	1	オサIBネジリハネ	SPRING, TWIST	

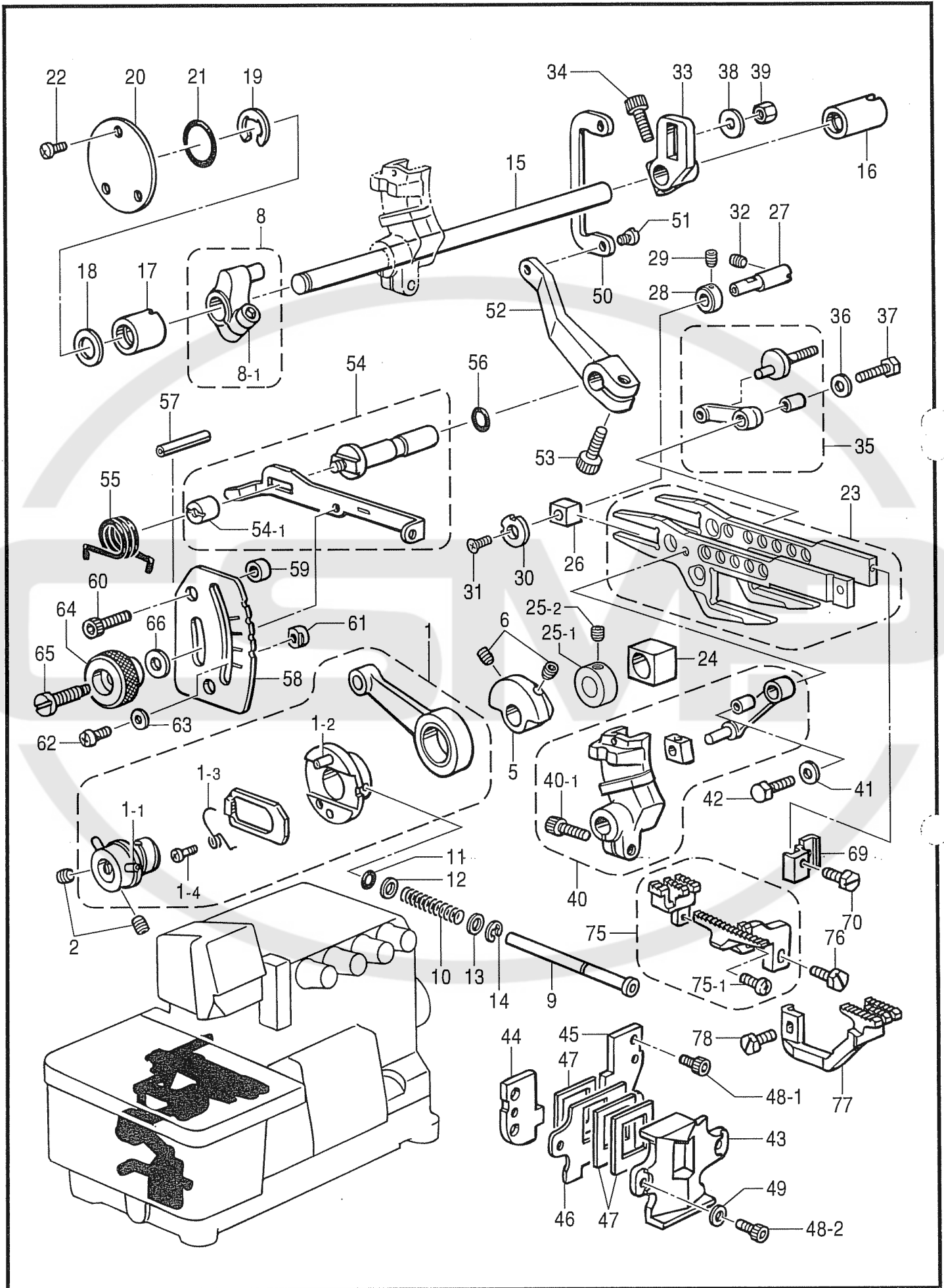

G. 送り関係 / Feed mechanism

REF.NO	CODE	QTY	品名	NAME OF PARTS	RM
1	S39578001	1	偏心リンク	ECCENTRIC WHEEL ASSY	
1-1	047301242	2	スプリングピンAW3	PIN, SPRING ROLL AW3	
1-2	047301242	1	スプリングピンAW3	PIN, SPRING ROLL AW3	
1-3	S39585001	1	ラチェットメネジリハネ	SPRING, TWIST	
1-4	S39586001	1	ハネメネジ 3	SCREW, M3	
2	012060632	2	アヒラ6X6	SET SCREW, SOCKET (FT) M6X6	
5	S39673020	1	バランスウエイト	BALANCE WEIGHT	
6	012060632	2	アヒラ6X6	SET SCREW, SOCKET (FT) M6X6	
8	S39589021	1	オクリウテクミ	FEED ARM ASSY	
8-1	018061632	1	アナホルト6X16	BOLT, SOCKET M6X16	
9	S39674001	1	オクリチヨウセツホタンシク	FEED ADJUSTING SHAFT	
10	S39675001	1	ホタンシクハネ	SPRING, COMPRESSION	
11	081005070	1	Oリング P5	O RING, P5	
12	025710232	1	ヒラサカネチユウ4.76	WASHER, PLAIN M 4.76	
13	025710232	1	ヒラサカネチユウ4.76	WASHER, PLAIN M 4.76	
14	048040342	1	トメ7E4	RETAINING RING, E4	
15	S39676121	1	オクリシク	FEED SHAFT	
16	S39677021	1	メタル11.11-17	BUSH, 11.11-17	
17	S39678021	1	オクリシクメタル	BUSH, L ;FEED SHAFT	
18	S30562000	1	サカネ	WASHER	
19	048090342	1	トメ7E9	RETAINING RING, E9	
20	S39679001	1	オクリシクメタルフタ	CAP	
21	081020070	1	Oリング P20	O RING, P20	
22	060400612	3	ハイント M4X6	SCREW, BIND M4X6	
23	S50091001	1	オクリタイクミ	FEED BRACKET ASSY	
24	S38312050	1	シヨウカオクリカコマ	SLIDE BLOCK, F-LIFTING	
25-1	S44955001	1	セツカラー	SET SCREW COLLAR	
25-2	012060632	1	アヒラ6X6	SET SCREW, SOCKET (FT) M6X6	
26	S39683000	1	オクリタイクカコマ	SLIDE BLOCK, F-BAR	
27	S39684021	1	オクリタイクカコマシク	SHAFT, ;SLIDE BLOCK	
28	S39685001	1	セツカラー	SET SCREW COLLAR	
29	012400432	1	アヒラ4X4	SET SCREW, SOCKET (FT) M4X4	
30	S20530001	1	サカネ	WASHER	
31	004350812	1	サラコ35X8	SCREW, FLAT M3.5X8	
32	012400832	1	アヒラ4X8	SET SCREW, SOCKET (FT) M4X8	
33	S42042021	1	シユオクリウテ	MAIN FEED ARM	
34	018061632	1	アナホルト6X16	BOLT, SOCKET M6X16	
35	S39773001	1	シユオクリリンク	MAIN FEED LINK ASSY	
36	S39690021	1	サカネ	WASHER	
37	S23360001	1	ホルト5X15	BOLT, M5X15	
38	S02573020	1	サカネ	WASHER	
39	S39691001	1	ナット5	NUT, M5	
40	S39769051	1	サトウオクリウテリンク	DIF. FEED ARM LINK ASSY	
40-1	018061632	1	アナホルト6X16	BOLT, SOCKET M6X16	
41	S39690021	1	サカネ	WASHER	
42	S23360001	1	ホルト5X15	BOLT, M5X15	
43	S38311100	1	オクリタイアンイカハ	COVER, FEED BAR GUIDE	
44	S39686000	1	オクリタイアンイ	FEED BAR GUIDE, L	
45	S39687000	1	オクリタイアンイR	FEED BAR GUIDE, R	
46	S39688001	1	ホウジンイタササエ	FRAGMENT PROTECTOR PLATE	
47	S20526000	3	ホウジンイタ	FRAGMENT PROTECTOR PLATE	
48-1	S43916001	4	アナホルト4X8シール	BOLT, SOCKET M4X8 SEAL	
48-2	018400832	2	アナホルト4X8	BOLT, SOCKET M4X8	
49	025040132	2	ヒラサカネシヨウ4	WASHER, PLAIN S 4	
50	S39692021	1	サトウチヨウセツリンク	DIF. FEED ADJUSTING LINK	
51	S20543101	1	シメネジ 5	SCREW, M5	
52	S20544000	1	サトウリンクレバ	DIFFERENTIAL LINK LEVER	
53	018061432	1	アナホルト6X14	BOLT, SOCKET M6X14	
54	S39593021	1	サトウチヨウセツレバ	DIF. FEED ADJUSTING LEVER ASSY	
54-1	S39596021	1	マルナット6	NUT, ROUND M6	
55	S20547001	1	レバ	SPRING	

G. 送り関係 / Feed mechanism

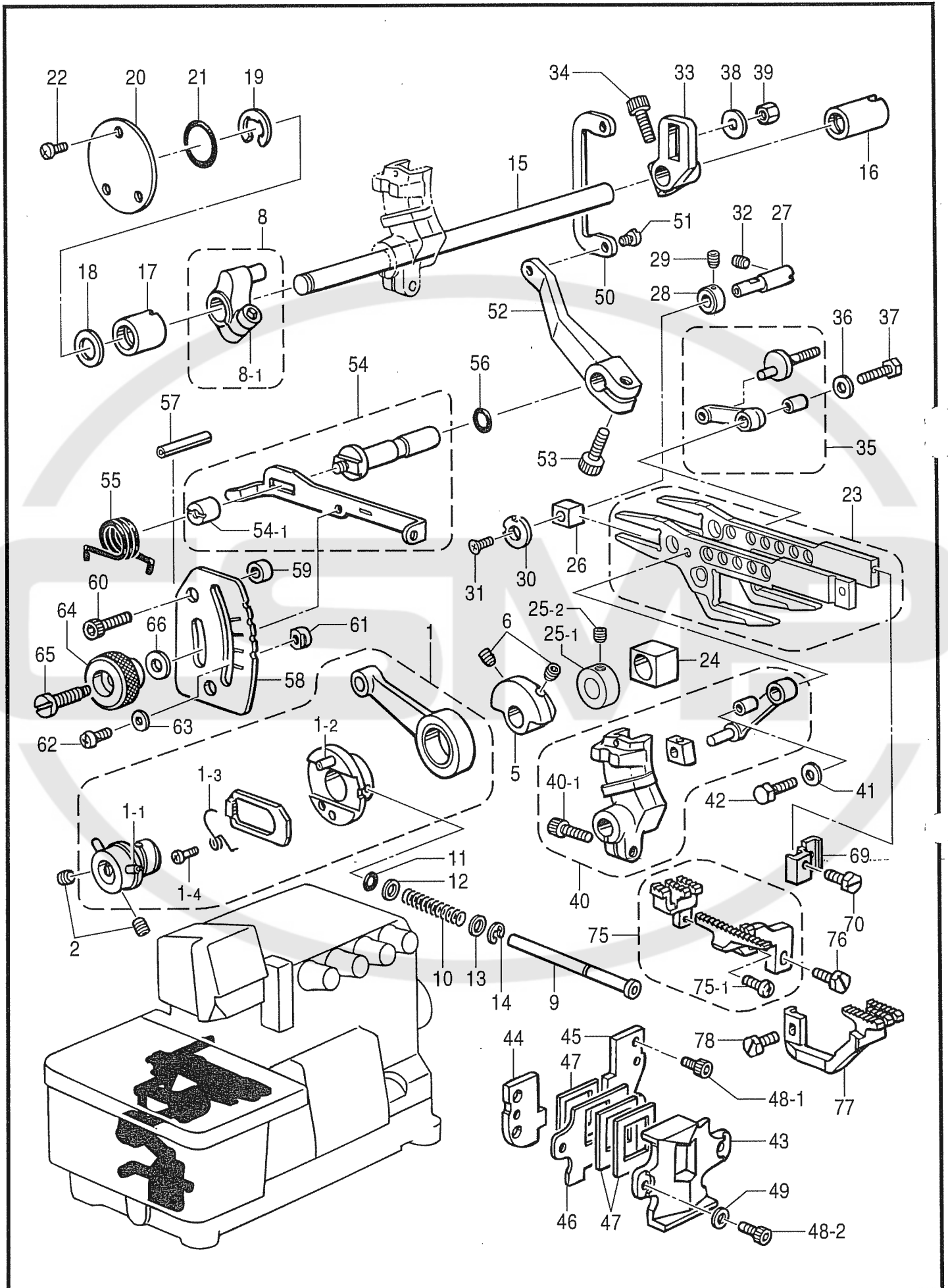

G. 送り関係 / Feed mechanism

REF.NO	CODE	Q'TY	ヒンメイ	NAME OF PARTS	RM
56	081005670	1	0リング PW5	O RING, PW5	
57	047502542	1	スプリングピンAW5	PIN, SPRING ROLL AW5	
58	S39693001	1	サトウヨウメリイタ	DIFFERENTIAL STITCH CONTROL	
59	S20548001	2	カラー	COLLAR	
60	018061632	2	アナホルト6X16	BOLT, SOCKET M6X16	
61	S25818051	2	チヨウセツレハーストツハ	STOPPER, ;ADJUSTING LEVER	
62	060350812	2	ハイント 35X8	SCREW, BIND M3.5X8	
63	025350332	2	ヒラサガネタ 13.5	WASHER, PLAIN L 3.5	
64	S39694021	1	セツネシツマミ	KNOB, SCREW	
65	S39695001	1	セツネシ	SET SCREW	
66	S20560001	1	サラハネサガネ	WASHER, FLAT SPRING	
69	S23628101	1	シユオクリハトリツタイ	FEED DOG SETTING BASE	
70	S23621101	1	ホルト35X8	BOLT, M3.5X8	
75	*	1	シユオクリハクミ	MAIN FEED DOG ASSY	
75-1	060630712	1	ハイント 238-56X7	SCREW, BIND SM2.38-56X7	
76	S23621101	1	ホルト35X8	BOLT, M3.5X8	
77	*	1	サトウオクリハ	DIFFERENTIAL FEED DOG	
78	S23621101	1	ホルト35X8	BOLT, M3.5X8	

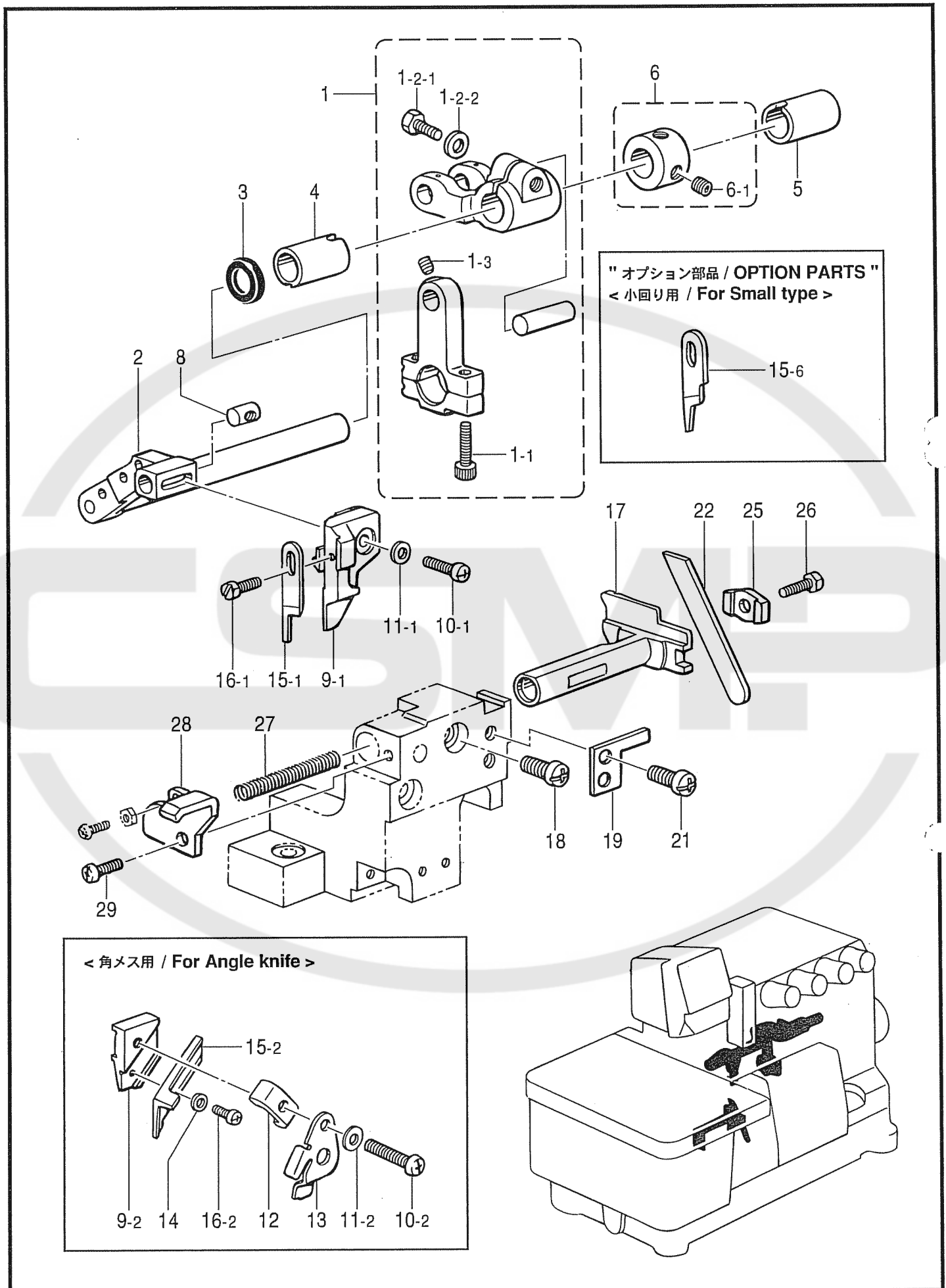

H. 上メス・下メス関係 / Knife mechanism

REF.NO	CODE	Q'TY	ヒンメイ	NAME OF PARTS	RM
1	S54011001	1	ウワメスクランクロッドクミ	UPPER KNIFE CRANK ROD ASSY, I	
1-1	018401622	2	アナホルト4X16	BOLT, SOCKET M4X16	
1-2-1	017061612	1	ホルト6X16	BOLT, M6X16	
1-2-2	118735002	1	サガネ	WASHER, PLAIN	
1-3	S23342001	1	アトカリ4X5	SET SCREW, SOCKET (CN) M4X5	
2	S20571101	1	ウワメスサトウウテ	UPPER KNIFE DIFFERENTIAL ARM	
3	155247000	1	タストシール	DUST SEAL	
4	S39704021	1	ウワメスメタル	UPPER KNIFE BUSH, L	
5	S39677021	1	メタル11.11-17	BUSH, 11.11-17	
6	S43527001	1	セットカラークミ	SET SCREW COLLAR ASSY	
6-1	012060632	2	アヒラ6X6	SET SCREW, SOCKET (FT) M6X6	
8	S20574001	1	ウワメスタキナツト	NUT	
9-1	S20589101	1	<上メス用> ウワメスタキ	<For Taping> UPPER KNIFE HOLDER	
10-1	062401212	1	ナハコ4X12	SCREW, PAN M4X12	
11-1	025040132	1	ヒラサガネネヨウ4	WASHER, PLAIN S 4	
15-1	144074350	1	ウワメス	UPPER KNIFE	
16-1	S23621101	1	ホルト35X8	BOLT, M3.5X8	
9-2	S20590101	1	<角メス用> ウワメスタキ	<For Taping> UPPER KNIFE HOLDER	
10-2	062402512	1	ナハコ4X25	SCREW, PAN M4X25	
11-2	125324001	1	ヒラサガネネタ14アツ	WASHER	
12	S20577001	1	ウワメスオサエ	UPPER KNIFE PRESSER	
13	S20578101	1	ウワメスオサエイタ	UPPER KNIFE PRESSER PLATE	
14	025030132	1	ヒラサガネネヨウ3	WASHER, PLAIN S 3	
15-2	*	1	カクメス	ANGLE KNIFE, NARROW	
16-2	062300412	1	ナハコ3X4	SCREW, PAN M3X4	
17	S20591101	1	シタメストリツタダイ	LOWER KNIFE HOLDER	
18	062060812	1	ナハコ6X8	SCREW, PAN M6X8	
19	S39707001	1	シタメストリツタダイアンナイ	LOWER KNIFE HOLDER GUIDE	
21	062060812	2	ナハコ6X8	SCREW, PAN M6X8	
22	*	1	シタメス	LOWER KNIFE	
25	S39708001	1	シタメスオサエ	LOWER KNIFE PRESSER	
26	017500812	1	ホルト5X8	BOLT, M5X8	
27	S20585001	1	シタメストリツタダイハネ	SPRING, COMPRESSION	
28	S39709021	1	シタメスハネウケ	SPRING HOLDER	
29	060400812	1	ハイントM4X8	SCREW, BIND M4X8	
15-2	S20896101	1	カクメス <幅狭>	"OPTION PARTS" ANGLE KNIFE, NARROW	
15-3	S20897101	1	カクメス <幅狭 波刃>	ANGLE KNIFE, NARROW WAVE EDGE	
15-4	S20579101	1	カクメス <幅広>	ANGLE KNIFE, WIDE	
15-5	S20898101	1	カクメス <幅広 波刃>	ANGLE KNIFE, WIDE WAVE EDGE	
15-6	S30890000	1	ウワメス <小回り用>	UPPER KNIFE	

< バインディング用 / For Binding >

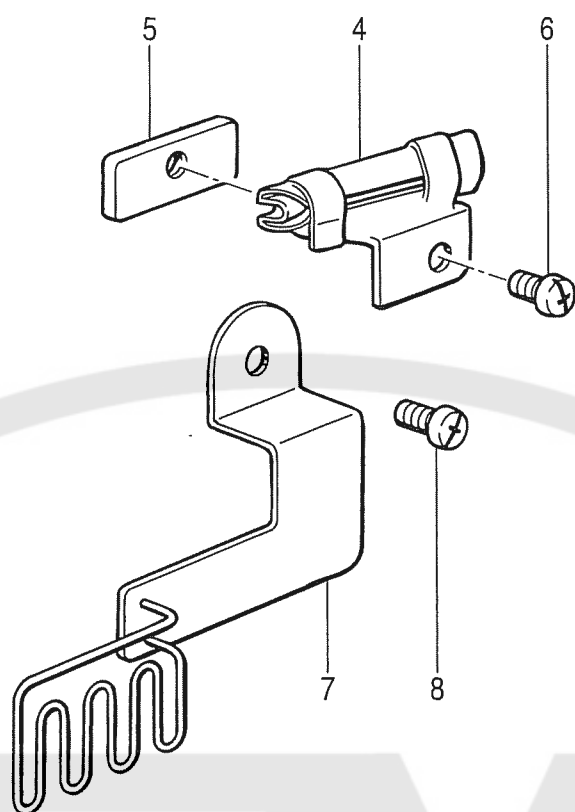

878-N31-239

J. ラッパ一関係 / Lapper mechanism

REF.NO	CODE	QTY	ヒンメイ	NAME OF PARTS	RM
4	S29824000	1	<ハインディング用> ラッパ-8クミ <テープ幅8mm>	<For Binding> LAPPER ASSY, 8.....<Tape width 8mm>	
4	S29827000	1	ラッパ-10クミ <テープ幅10mm>	LAPPER ASSY, 10.....<Tape width 10mm>	
5	S29835001	1	ラッパ-アンナイタ	LAPPER GUIDE PLATE	
6	S23418002	1	シメネジ 4X5	SCREW, M4X5	
7	S29831000	1	テープアンナイタ	LAPPER GUIDE ASSY	
8	060400612	1	ハイント M4X6	SCREW, BIND M4X6	

878-N31-239

K. 上ルーパ関係 / Over looper mechanism

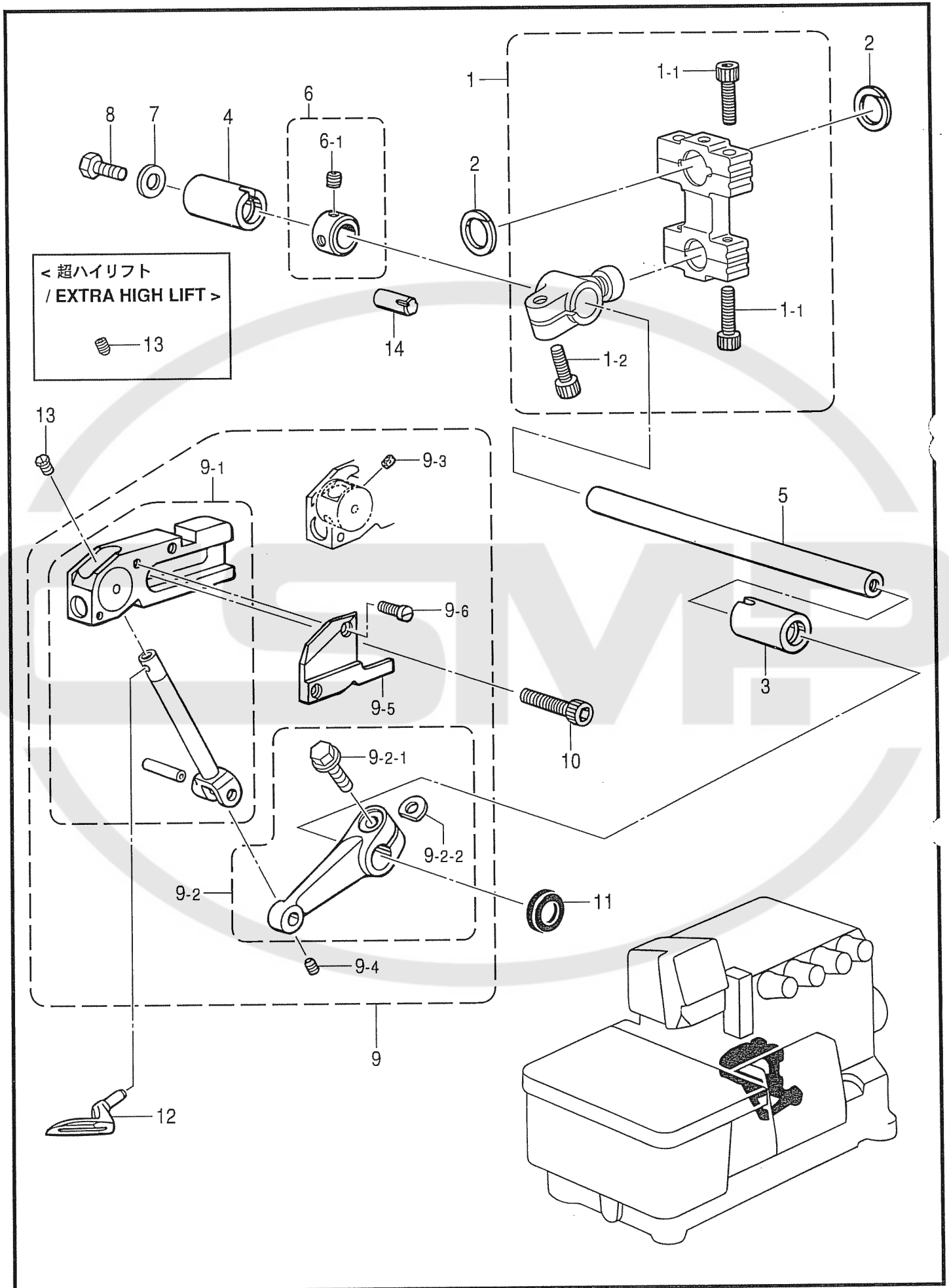

K. 上ルーパー関係 / Over looper mechanism

REF.NO	CODE	Q'TY	ヒンメイ	NAME OF PARTS	RM
1 1-1 1-2	S54012001 018401622 S23346101	1 4 1	<スタンダード用> ウールーハ°ロツト°クミS アナホルト4X16 アナホルト6X14ホソメ	<For Standard lift> OVER LOOPER CON. ROD ASSY, S BOLT, SOCKET M4X16 BOLT, SOCKET M6X14	
1 1-1 1-2	S54015001 018401622 S23346101	1 4 1	<ハイリフト用> ウールーハ°ロツト°クミHE アナホルト4X16 アナホルト6X14ホソメ	<For High lift> OVER LOOPER CON. ROD ASSY, HE BOLT, SOCKET M4X16 BOLT, SOCKET M6X14	
2 3 4 5 6 6-1 7 8	S20598000 S39728021 S39677021 S20601001 S43527001 012060632 S23626001 017060812	2 1 1 1 1 2 1 1	ロツト°フレ°メ メタル11.11-18 メタル11.11-17 ウールーハ°シク セツトカテー°クミ アナヒラ6X6 サ°ガ°ネ ホルト6X8	ROD STOPPER BUSH, 11.11-18 BUSH, 11.11-17 OVER LOOPER SHAFT SET SCREW COLLAR ASSY SET SCREW, SOCKET (FT) M6X6 WASHER BOLT, M6X8	
9 9-1 9-2 13	S52053001 S52054001 S52060001 S46903001	1 1 1 1	<スタンダード、ハイリフト用> ウールーハ°キコウソク°クミSH ウールーハ°キコウ°クミ ウールーハ°ウテ°SH°クミ アタマツキ°メネジ°4X5	<For Standard lift & High lift> OVER LOOPER SET, SH OVER LOOPER ASSY OVER LOOPER ARM ASSY, SH SET SCREW, M4X5	
9 9-1 9-2 13	S52062001 S52054001 S52063001 012400432	1 1 1 1	<超ハイリフト用> ウールーハ°キコウソク°クミSH ウールーハ°キコウ°クミ ウールーハ°ウテ°E°クミ アナヒラ4X4	<For Extra high lift> OVER LOOPER SET, E OVER LOOPER ASSY OVER LOOPER SET SCREW, SOCKET (FT) M4X4	
9-2-1 9-2-2 9-3 9-4 9-5 9-6 10 11 12 14	S46899001 155162001 S29700000 S23342001 S52059001 S20355002 018061432 155247000 * 118550001	1 1 2 1 1 2 2 1 1 1	サ°ガ°ネツキ°ホルト6X16 スハ°ーサ ウールーハ°アンナイ°フェルト アナト°ガ°リ4X5 ウールーハ°アンナイ°オサエ シメ°ネジ°3X8.5 アナホルト6X14 タ°スト°シール ウールーハ° ミゾ°ツキ°ピン	BOLT, (W/WASHER) M6X16 SPACER FELT SET SCREW, SOCKET (CN) M4X5 OVER LOOPER GUIDE SUPPORT SCREW, M3X8.5 BOLT, SOCKET M6X14 DUST SEAL OVER LOOPER PIN, DOWEL	

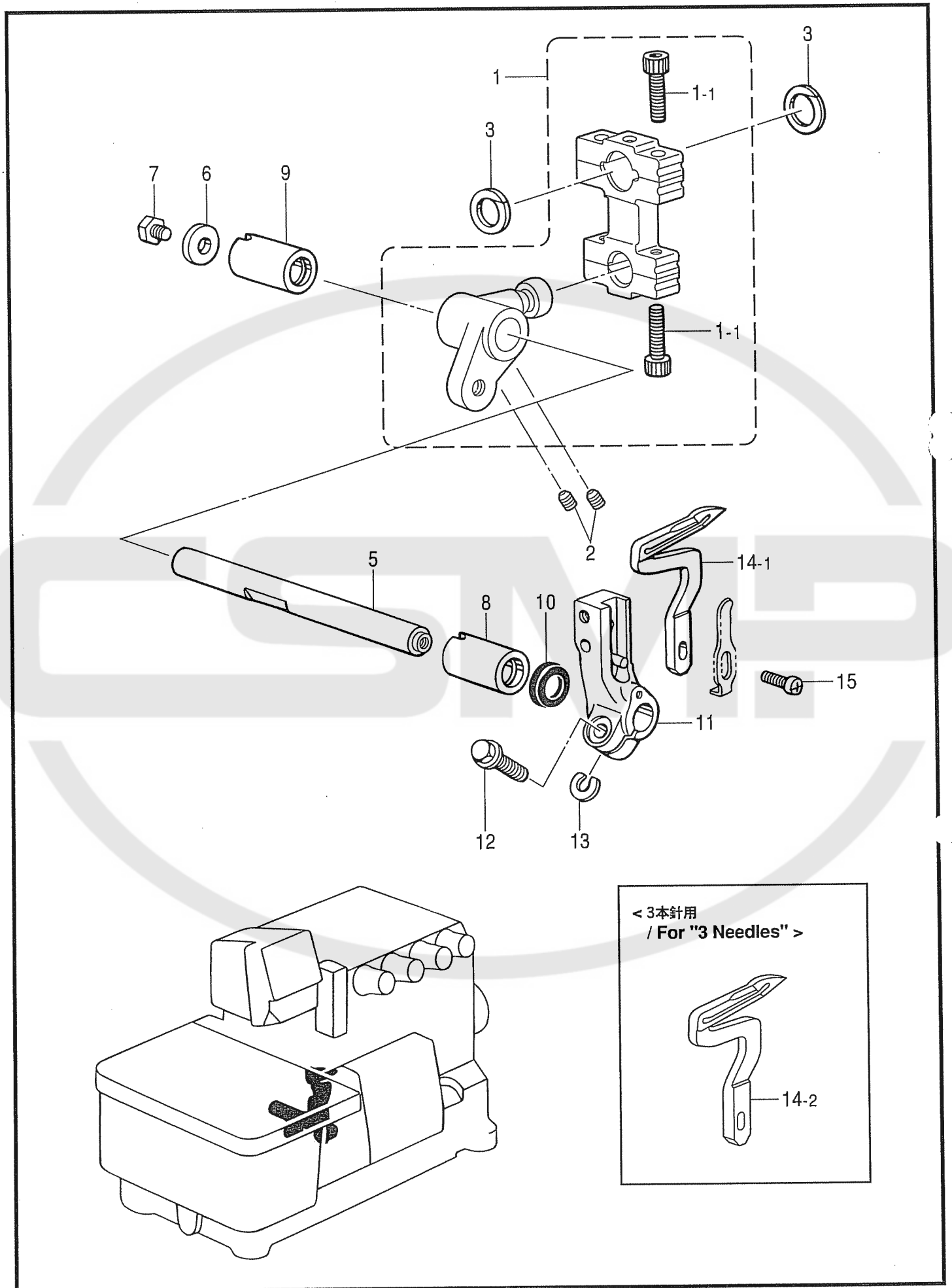

L. 下ルーパー関係 / Under looper mechanism

REF.NO	CODE	Q'TY	ヒンメイ	NAME OF PARTS	RM
1 1-1	S54018001 018401622	1 4	<スタンダード、ハイリフト用> シタルハ°ロツトクミISH アナホ°ルト4X16	<For Standard lift & High lift> U/LOOPER CON. ROD ASSY, ISH BOLT, SOCKET M4X16	
1 1-1	S54019001 018401622	1 4	<超ハイリフト用> シタルハ°ロツトクミIE アナホ°ルト4X16	<For Extra high lift> U/LOOPER CON. ROD ASSY, IE BOLT, SOCKET M4X16	
2 3 5 6 7 8 9 10 11 12 13 14-1 15	012060632 S20598000 S46904001 S23626001 017060812 S39728021 S39677021 155247000 S20625151 S23614101 148782001 S20626001 060351012	2 2 1 1 1 1 1 1 1 1 1 1 1 1	アナヒラ6X6 ロツト°フレ°メ シタルハ°シク サ°カ°ネ ホ°ルト6X8 メタル11.11-18 メタル11.11-17 タ°ストシール シタルハ°トリツケタイ フランシ°ホ°ルト5X14 スハ°-サ シタルハ° ハ°イント°3.5X10	SET SCREW, SOCKET (FT) M6X6 ROD STOPPER UNDER LOOPER SHAFT WASHER BOLT, M6X8 BUSH, 11.11-18 BUSH, 11.11-17 DUST SEAL UNDER LOOPER HOLDER BOLT, M5X14 SPACER UNDER LOOPER SCREW, BIND M3.5X10	
14-2	S20627001	1	<3本針用> シタルハ°	<For "3 Needles"> UNDER LOOPER	

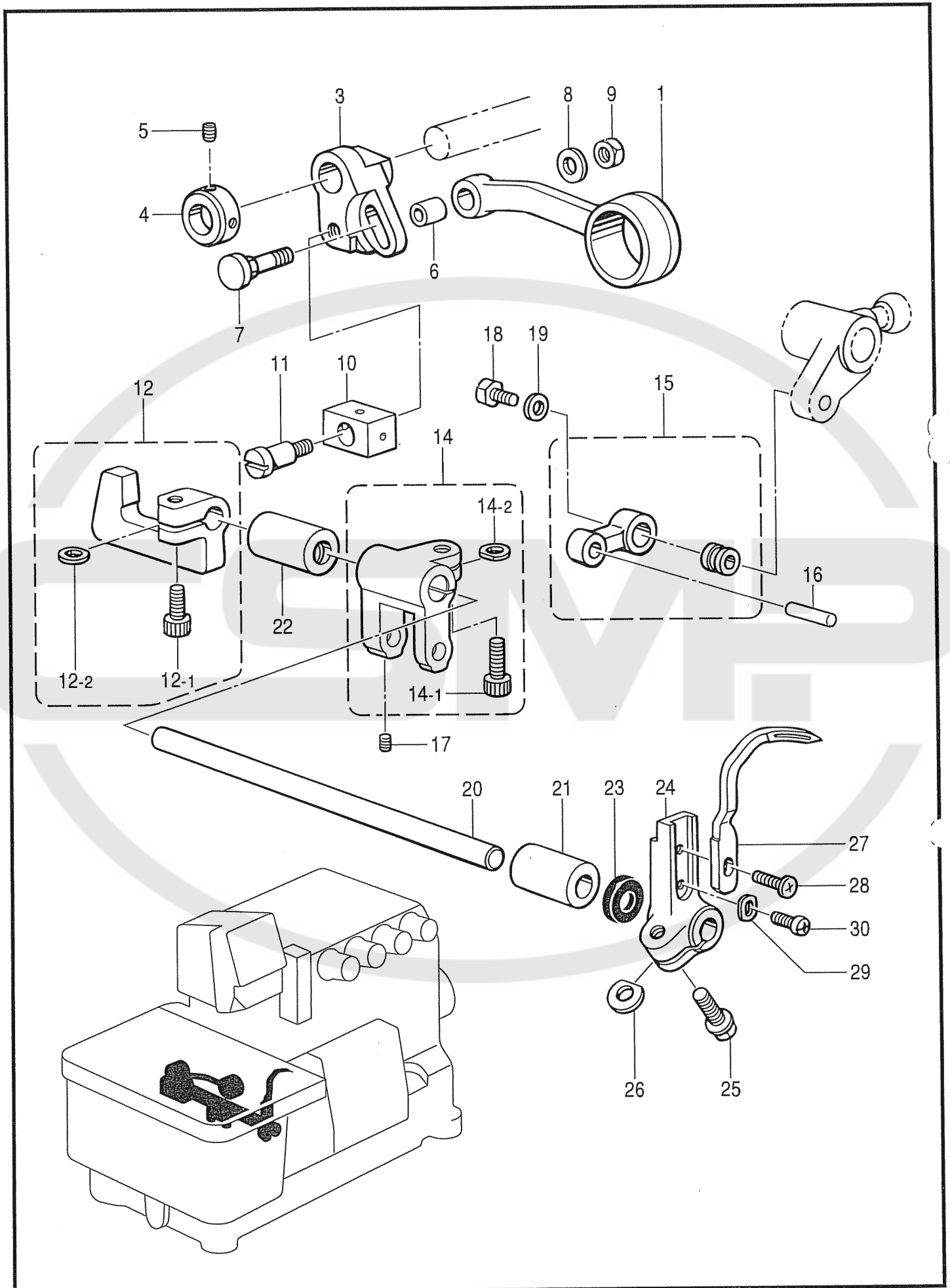

M. 二重環ルーパ関係 / Double chain stitch looper mechanism

REF.NO	CODE	QTY	ヒンメイ	NAME OF PARTS	RM
1	S39729021	1	セ`ンゴ`ロツ`クミ	LONGITUDINAL FEED ROD ASSY	
3	S39732021	1	セ`ンゴ`ウテ`	LONGITUDINAL FEED ARM	
4	S39733001	1	セツカラー	SET SCREW COLLAR	
5	012400432	2	ア`ヒラ`4X4	SET SCREW, SOCKET (FT) M4X4	
6	S29102001	1	セ`ンゴ`ロツ`フ`ツシ	LONGITUDINAL FEED ROD BUSH	
7	S39734021	1	セ`ンゴ`ウテ`ネジ`	LONGITUDINAL FEED SCREW	
8	S39690021	1	サ`カ`ネ	WASHER	
9	021500216	1	2`シユ`ナツト`5	NUT, 2 M5	
10	S39735050	1	セ`ンゴ`ウテ`カコ`マ	LONGITUDINAL FEED SLIDE BLOCK	
11	S20641001	1	タ`ン`ネジ`5	SHOULDER SCREW 5	
12	S31881101	1	カコ`マ`タ`キネジ`ツキ	SLIDE BLOCK HOLDER	
12-1	018061432	1	ア`ホ`ルト`6X14	BOLT, SOCKET M6X14	
12-2	155162001	1	ス`パ`-サ	SPACER	
14	S44935101	1	ニジ`ユウ`カン`ウテ`クミ	D-CHAIN STITCH LOOPER LEVER	
14-1	018061432	1	ア`ホ`ルト`6X14	BOLT, SOCKET M6X14	
14-2	155162001	1	ス`パ`-サ	SPACER	
15	S44937101	1	ニジ`ユウ`カン`リンク`クミ	D-CHAIN STITCH LOOPER LINK	
16	S44939001	1	ニジ`ユウ`カン`ウテ`シク	SHAFT	
17	062300612	1	ナ`ハ`コ`3X6	SCREW, PAN M3X6	
18	S23360001	1	ホ`ルト`5X15	BOLT, M5X15	
19	S57922001	1	サ`カ`ネ	WASHER	
20	S39740021	1	セ`ンゴ`シク`	LONGITUDINAL FEED SHAFT	
21	S39741021	1	セ`ンゴ`シク`メタル`F	LONGITUDINAL FEED SHAFT BUSH,F	
22	S39742021	1	セ`ンゴ`シク`メタル`B	LONGITUDINAL FEED SHAFT BUSH, B	
23	155261000	1	タ`スト`シール	DUST SEAL	
24	S20652001	1	ニジ`ユウ`カン`ル-ハ`ホル`ダ`	D-CHAIN STITCH LOOPER HOLDER	
25	S23614101	1	フ`ラン`ジ`ホ`ルト`5X14	BOLT, M5X14	
26	148782001	1	ス`パ`-サ	SPACER	
27	S20653001	1	ニジ`ユウ`カン`ル-ハ`	D-CHAIN STITCH LOOPER	
28	060350812	1	ハ`イ`ント`35X8	SCREW, BIND M3.5X8	
29	S20654001	1	ル-ハ`チ`ヨウ`セツ`サ`カ`ネ	WASHER	
30	S23456101	1	ナ`ハ`コ`25X6	SCREW, PAN M2.5X6	

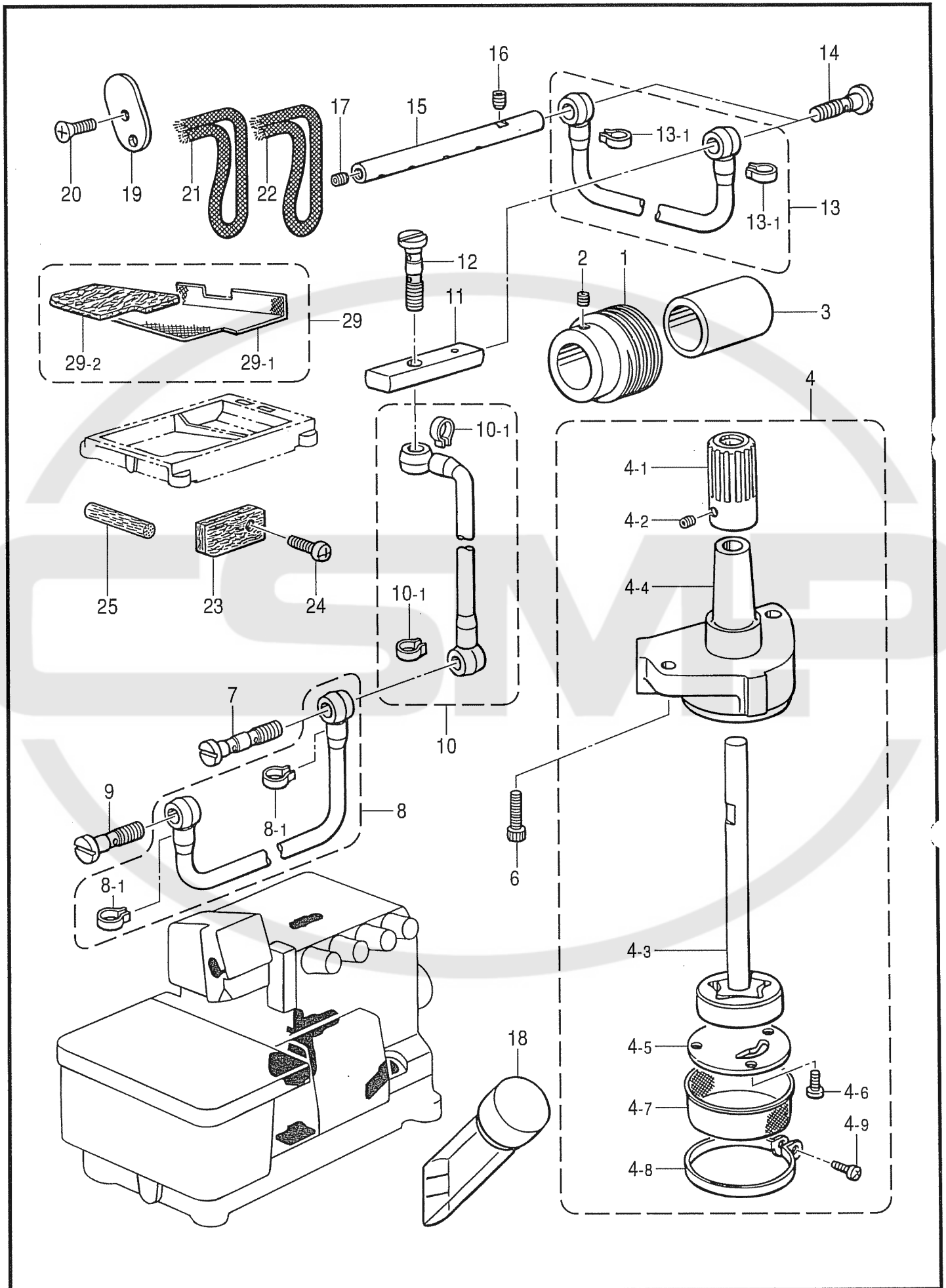

N. 給油潤滑関係 / Lubrication

REF.NO	CODE	Q'TY	ヒンメイ	NAME OF PARTS	RM
1	S20655101	1	ウオーム	WORM	
2	012500532	2	アナヒラ5X5	SET SCREW, SOCKET (FT) M5X5	
3	S39743001	1	カラー	COLLAR	
4	S39597001	1	トロコイト°ポン°クミ	PUMP ASSY	
4-1	S20657001	1	ウオームホイール	WORM WHEEL	
4-2	012400432	2	アナヒラ4X4	SET SCREW, SOCKET (FT) M4X4	
4-3	S39599001	1	ポン°ローター°クミ	PUMP INNER ROTER ASSY	
4-4	S39598000	1	ポン°ケース	PUMP CASE	
4-5	S39601000	1	ポン°タイフタ	PUMP BODY COVER	
4-6	062400812	3	ナハ°コ4X8	SCREW, PAN M4X8	
4-7	S39602000	1	ロカモウ	OIL FILTER	
4-8	S39603001	1	ロカモウサヤ	OIL FILTER FLANGE	
4-9	062401212	1	ナハ°コ4X12	SCREW, PAN M4X12	
6	018061432	2	アサボ°ルト6X14	BOLT, SOCKET M6X14	
7	S39744021	1	ハイユハ°イ°ツキ°テ	OIL PIPE JOINT	
8	S39745001	1	ビ°ニルチューブ°クミ	OIL TUBE ASSY	
8-1	147942001	2	ビ°ニルチューブ°トメカ°ネ	STOP RING	
9	S20199001	1	ハイユハ°イ°ツキ°テ	OIL PIPE JOINT	
10	S39747001	1	ビ°ニルチューブ°クミ	OIL TUBE ASSY	
10-1	147942001	2	ビ°ニルチューブ°トメカ°ネ	STOP RING	
11	S39751021	1	キユウハ°イ°	OIL PIPE	
12	S39744021	1	ハイユハ°イ°ツキ°テ	OIL PIPE JOINT	
13	S39749001	1	ビ°ニルチューブ°クミ	OIL PIPE ASSY	
13-1	147942001	2	ビ°ニルチューブ°トメカ°ネ	STOP RING	
14	S20199001	2	ハイユハ°イ°ツキ°テ	OIL PIPE JOINT	
15	S39752021	1	ロツト°キユウハ°イ°	OIL PIPE	
16	012400432	1	アナヒラ4X4	SET SCREW, SOCKET (FT) M4X4	
17	012060632	1	アナヒラ6X6	SET SCREW, SOCKET (FT) M6X6	
18	148084001	1	オイルゲ°ー°シ°マ°ト°	OIL GAUGE WINDOW	
19	S20668200	1	ハリボ°ウリンク°フェルト	FELT, ;N-BAR LINK	
20	061400812	1	サラコM4X8	SCREW, FLAT M4X8	
21	S49337000	1	クミヒモ70	WICK, L=70	
22	S20671000	1	クミヒモ100	WICK, L=100	
23	S20669000	1	フェルト	FELT	
24	060400812	1	ハ°イント°M4X8	SCREW, BIND M4X8	
25	S20392000	1	フェルト	FELT	
29	S43523000	1	フィルタ°クミ	FILTER ASSY	
29-1	S43521000	1	ロカモウD	FILTER, D	
29-2	S43522000	1	オイルフィルタ°	OIL FILTER	

< 3本針用
/ For "3 Needles" >

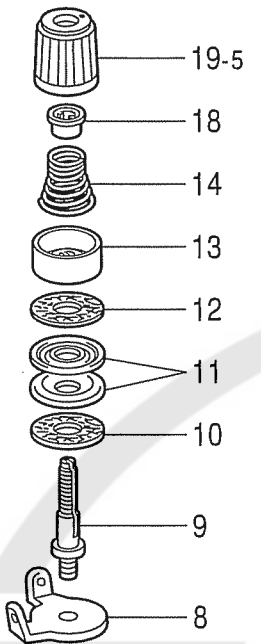

< 3本針用
/ For "3 Needles" >

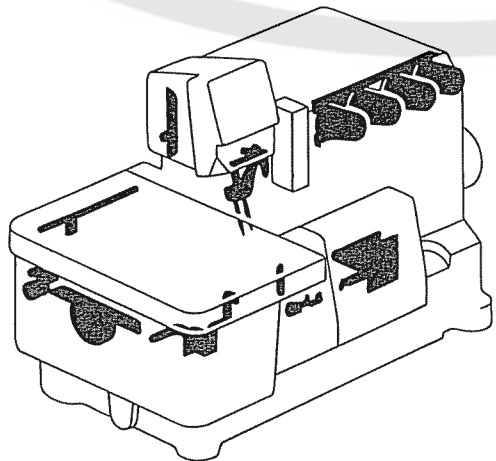
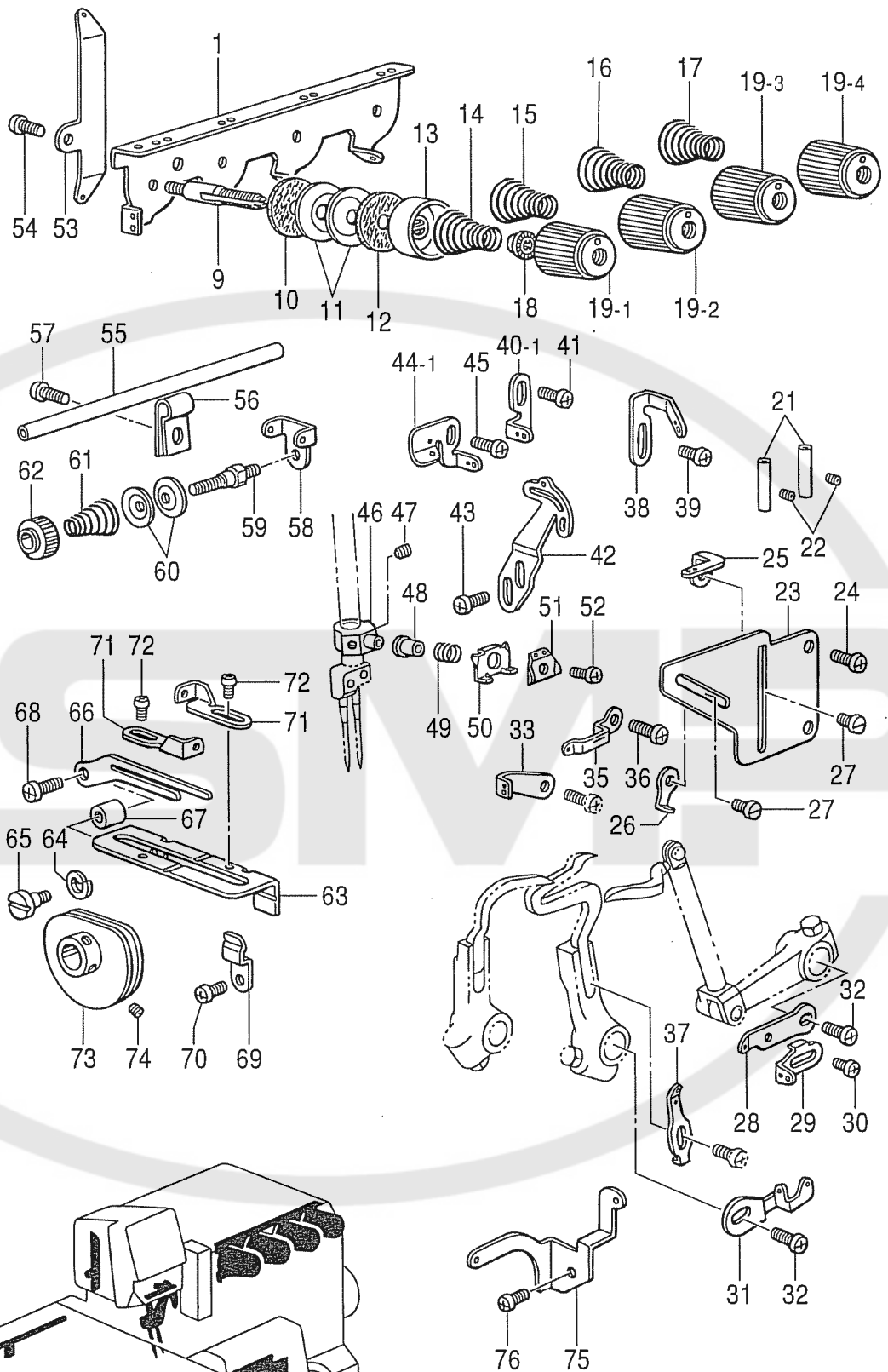
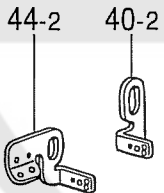

P. 糸調子関係 / Thread tension

REF.NO	CODE	Q'TY	ヒンメイ	NAME OF PARTS	RM
1	S38328051	1	シウトアンナイ	MAIN THREAD GUIDE	
9	S20676051	4	トチヨウシホウ	TENSION STUD	
10	S20677000	4	トチヨウシサヲエルト	FELT, T-DISC	
11	S20673001	8	トチヨウシサヲ	TENSION DISC	
12	110832009	4	トチヨウシサヲエルト	FELT, ;T-DISC	
13	144103009	4	トチヨウシサヲオサエ	DISC PRESSER, ;TENSION	
14	S20678001	1	トチヨウシハネ	TENSION SPRING, L	
15	S32276001	1	トチヨウシハネLL	TENSION SPRING, LL	
16	S20679001	1	トチヨウシハネM	TENSION SPRING, M	
17	S20679001	1	トチヨウシハネM	TENSION SPRING, M	
18	S20681000	4	チヨウシハネウエサガネ	WASHER	
19-1	S20682103	1	トチヨウシナツト . . . <赤>	TENSION NUT, RED	
19-2	S20682101	1	トチヨウシナツト . . . <水色>	TENSION NUT, LIGHT BLUE	
19-3	S20682104	1	トチヨウシナツト . . . <黄>	TENSION NUT, YELLOW	
19-4	S20682102	1	トチヨウシナツト . . . <緑>	TENSION NUT, GREEN	
21	146592001	2	トアンナイハイフ	THREAD GUIDE PIPE	
22	S23452002	2	アヒラ4X3.2	SET SCREW, SOCKET (FT) M4X3.2	
23	S20684101	1	トアンナイトダイ	THREAD GUIDE BRACKET	
24	060400612	2	ハイントM4X6	SCREW, BIND M4X6	
25	S20685001	1	シタルハトアンナイR	UNDER LOOPER THREAD GUIDE, R	
26	S20686001	1	ウアルハトアンナイR	OVER LOOPER THREAD GUIDE, R	
27	S23418002	2	シメネジ4X5	SCREW, M4X5	
28	S21133001	1	ウアルハテンヒンR	OVER LOOPER THREAD TAKE-UP, R	
29	S21134001	1	シタルハテンヒンR	UNDER LOOPER THREAD TAKE-UP,R	
30	060300412	1	ハイントM3X4	SCREW, BIND M3X4	
31	S21135001	1	ルハテンヒンL	LOOPER THREAD TAKE-UP, L	
32	060400612	2	ハイントM4X6	SCREW, BIND M4X6	
33	S21137001	1	ルハトアンナイM1	LOOPER THREAD GUIDE, M1	
35	S21136101	1	ウアルハトアンナイL	OVER LOOPER THREAD GUIDE, L	
36	060400612	1	ハイントM4X6	SCREW, BIND M4X6	
37	S20687001	1	シタルハトアンナイL	UNDER LOOPER THREAD GUIDE, L	
38	S38329001	1	ハリトアンナイC	NEEDLE THREAD GUIDE, C	
39	060400612	1	ハイントM4X6	SCREW, BIND M4X6	
40-1	S21126001	1	ハリトアンナイB	NEEDLE THREAD GUIDE, B	
41	060400612	1	ハイントM4X6	SCREW, BIND M4X6	
42	S21130051	1	ハリトテンヒンA	NEEDLE THREAD TAKE-UP, A	
43	060400612	2	ハイントM4X6	SCREW, BIND M4X6	
44-1	S21125001	1	ハリトアンナイA	NEEDLE THREAD GUIDE, A	
45	060400612	1	ハイントM4X6	SCREW, BIND M4X6	
46	S38330050	1	ハリトオサエホルダー	NEEDLE THREAD PRESSER HOLDER	
47	146427001	2	アトメネジ3.18ホウミ	SET SCREW, SOCKET (CP) SM3.18	
48	S20689001	1	ハリトオサエカラー	NEEDLE THREAD PRESSER COLLAR	
49	S20690001	1	ハリトオサエハネ	SPRING, COMPRESSION	
50	S20691001	1	ハリトオサエイタ	NEEDLE THREAD PRESSER PLATE	
51	S20743001	1	ハリトアンナイ	NEEDLE THREAD GUIDE	
52	060300612	1	ハイントM3X6	SCREW, BIND M3X6	
53	S20694001	1	DLトアンナイB	CHAIN STITCH THREAD GUIDE, B	
54	060400612	1	ハイントM4X6	SCREW, BIND M4X6	
55	S20695001	1	DLトアンナイハイフ	THREAD GUIDE PIPE	
56	S20696001	1	トアンナイハイフサエ	PIPE SUPPORT, ;TR-GUIDE	
57	060400612	1	ハイントM4X6	SCREW, BIND M4X6	
58	S20697001	1	DLチヨウシサヲイトアンナイ	LOOPER THREAD GUIDE	
59	S20698121	1	トチヨウシホウ	TENSION STUD	
60	144504001	2	トアンナイサヲ	DISC, THREAD GUIDE	
61	158782151	1	プレテンションハネ	PRE-TENSION SPRING	
62	155510001	1	トチヨウシナツト	TENSION NUT	
63	S39756021	1	トサハキトダイ	THREAD HANDLER BRACKET	
64	028050242	1	ハネサガネ2-5	WASHER, SPRING 2-5	
65	S20342001	1	タンネジ4	SHOULDER SCREW, M4	
66	S20701001	1	テンヒントサハキ	THREAD HANDLER	
67	S39757001	1	カラー	COLLAR	

< 3本針用
/ For "3 Needles" >

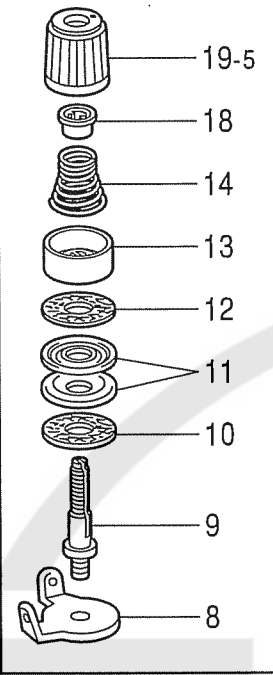

< 3本針用
/ For "3 Needles" >

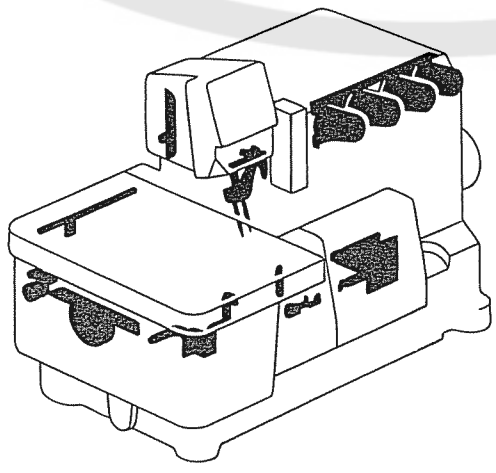
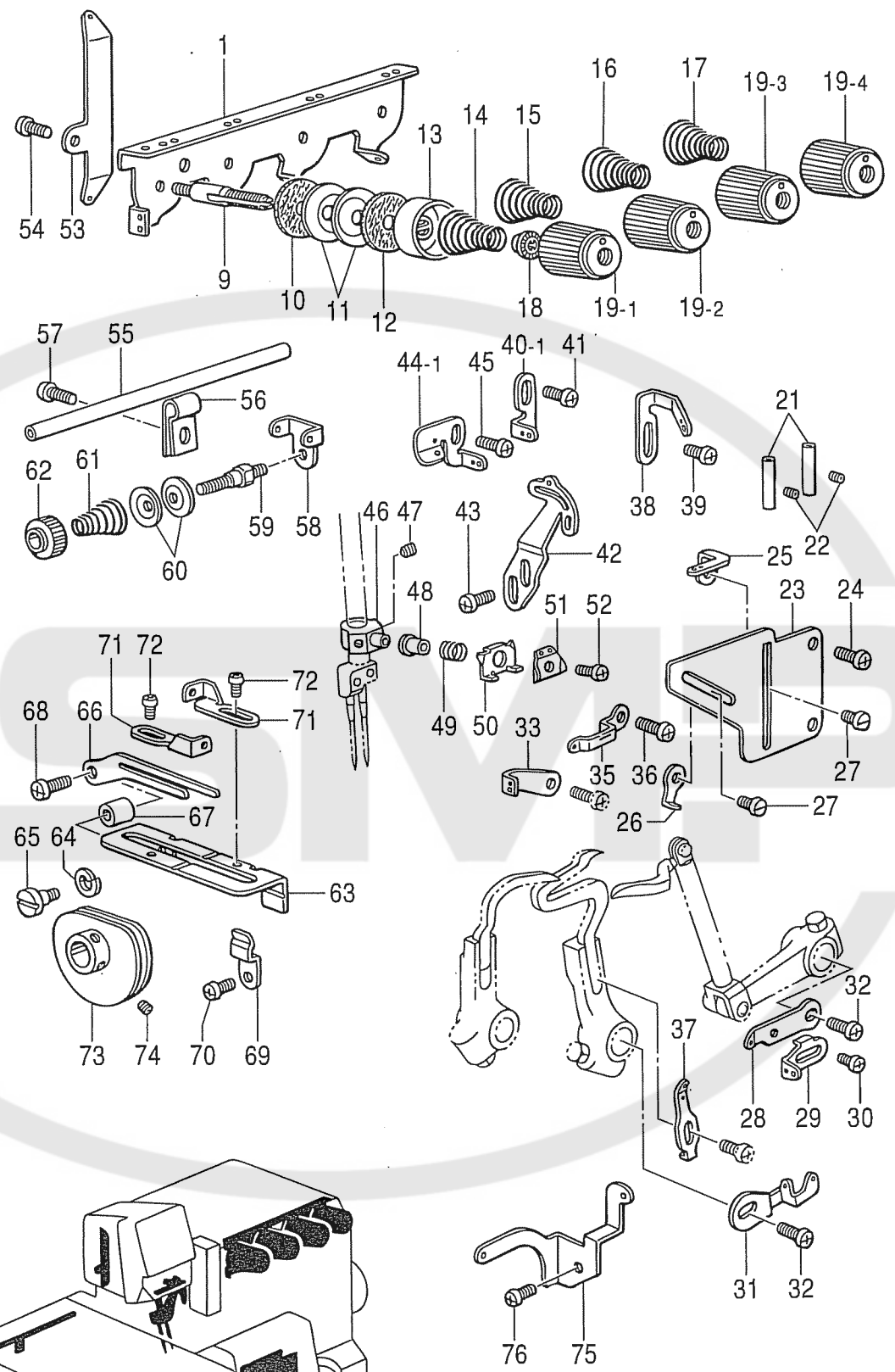
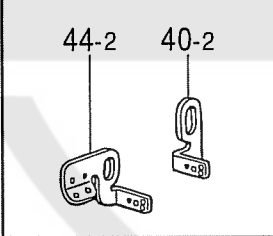

P. 糸調子関係 / Thread tension

REF.NO	CODE	QTY	ヒンメイ	NAME OF PARTS	RM
68	060401412	1	ハ`イント`M4X14	SCREW, BIND M4X14	
69	150813001	1	ト`ダ`イオサハ`ネ	SPRING	
70	062350612	1	ナ`コM3.5X6	SCREW, PAN M3.5X6	
71	S20702001	2	DLテン`ンイトアンナイ	THREAD TAKE-UP GUIDE	
72	S20158101	2	ナ`コ25X3	SCREW, PAN M2.5X3	
73	S20703051	1	DLテン`ンクミ	THREAD TAKE-UP LEVER ASSY, DL	
74	S23452002	2	アヒラ4X3.2	SET SCREW, SOCKET (FT) M4X3.2	
75	S20707001	1	DLトアンナイA	THREAD GUIDE, A ;DL	
76	060400612	1	ハ`イント`M4X6	SCREW, BIND M4X6	
8	S20675001	1	<3本針用> 子ヨウシライトアンナイ	<For "3 Needles"> TENSION DISC THREAD GUIDE	
9	S20676051	5	トヨウシホ`ウ	TENSION STUD	
10	S20677000	5	トヨウシサヲフェルト	FELT, T-DISC	
11	S20673001	10	トヨウシサヲ	TENSION DISC	
12	110832009	5	トヨウシサヲフェルト	FELT, ;T-DISC	
13	144103009	5	トヨウシサヲサエ	DISC PRESSER, ;TENSION	
14	S20678001	2	トヨウシハ`ネL	TENSION SPRING, L	
18	S20681000	5	子ヨウシハ`ネウエサ`カ`ネ	WASHER	
19-5	S20682103	2	トヨウシナツト. . . . <赤>	TENSION NUT, RED	
40-2	S21129001	1	ハリトアンナイB	NEEDLE THREAD GUIDE, B	
44-2	S21128001	1	ハリトアンナイA	NEEDLE THREAD GUIDE, A	

Q1 . ラフラー装置関係 / Ruffling attachment

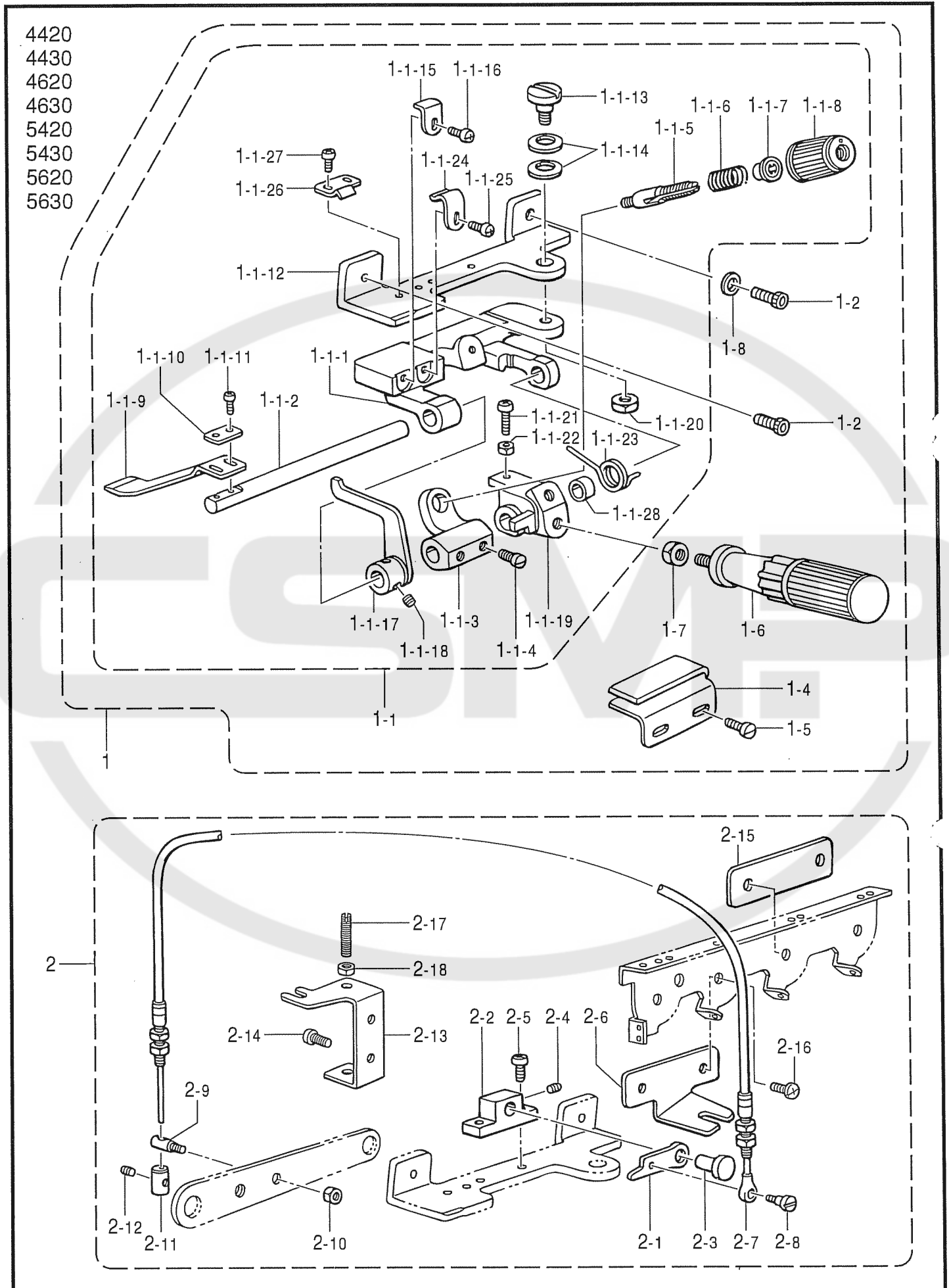

Q1. ラフラー装置関係 / Ruffling attachment

REF.NO	CODE	QTY	ヒンメイ	NAME OF PARTS	RM
1	S30304001	1	ラフラークミ	RUFFLER ASSY	
1-1	S21293001	1	ラフラーソウチクミ	RUFFLER DEVICE SET	
1-1-1	S21294001	1	キシオサイタイ	RUFFLING BLADE BRACKET	
1-1-2	S21295001	1	キシオサイトリツケシク	RUFFLING BLADE BASE SHAFT	
1-1-3	S21305001	1	ハネウケ	SPRING BASE	
1-1-4	S23777101	2	アタマツキトメネジ6	SET SCREW, M6	
1-1-5	S20676051	1	イトチヨウシホウ	TENSION STUD	
1-1-6	S23775001	1	コイルハネ	SPRING, COIL	
1-1-7	S20681000	1	チヨウシハネウエサガネ	WASHER	
1-1-8	S20682105	1	イトチヨウシナツト	TENSION NUT	
1-1-9	S21296001	1	キシオサ	RUFFLING BLADE	
1-1-10	144784001	1	キシオサウエサガネ	WASHER	
1-1-11	062300812	2	ナハコ3X8	SCREW, PAN M3X8	
1-1-12	S21297001	1	ラフラーソウチトリツケタイ	RUFFLER BASE	
1-1-13	S21306001	1	ダンネジ6	SHOULDER SCREW, M6	
1-1-14	S21307001	2	ハネサガネ	WASHER, SPRING	
1-1-15	S21298001	1	キシオサアナイ	RUFFLING BLADE GUIDE	
1-1-16	062400812	1	ナハコ4X8	SCREW, PAN M4X8	
1-1-17	S21299001	1	キシオサアケ	CLOTH PRESSER BAR LIFTER	
1-1-18	S23651002	2	アナヒラ6X6ホソメ	SET SCREW, SOCKET (FT) M6X5	
1-1-19	S21300001	1	ハンドルトリツケイタ	HANDLE SETTING PLATE	
1-1-20	021060302	1	ナツト3シユ6	NUT, 3 M6	
1-1-21	062401612	1	ナハコM4X16	SCREW, PAN M4X16	
1-1-22	021400212	1	2シユナツト4	NUT, 2 M4	
1-1-23	S21301001	1	ハンドルモトシハネ	SPRING, TWIST	
1-1-24	S21302001	1	キシオサイタイトマハネ	SPRING, PLATE (U)	
1-1-25	062400612	1	ナハコM4X6	SCREW, PAN M4X6	
1-1-26	S21303001	1	キシオサイタイトマハネ	SPRING, PLATE (D)	
1-1-27	062350512	2	ナハコ3.5X5	SCREW, PAN M3.5X5	
1-1-28	S21304001	1	カラー	COLLAR	
1-2	018401222	2	アナホルト4X12	BOLT, SOCKET M4X12	
1-4	S21590000	1	キシアナイ	RUFFLER GUIDE	
1-5	S23418002	2	シメネジ4X5	SCREW, M4X5	
1-6	S23779001	1	ハンドル	HANDLE	
1-7	021060302	1	ナツト3シユ6	NUT, 3 M6	
1-8	102707002	1	サガネ	WASHER, PLAIN 4	
2	S43530001	1	ラフラーオサイレントウクミ	RUFFLER INTERLOCKING PARTS SET	
2-1	S21310001	1	キシオサアケレハ	CLOTH PRESSER BAR LIFTER LEVER	
2-2	S21311001	1	オサアケタイ	PRESSER BAR LIFTER BRACKET	
2-3	S21312001	1	ピン6.35	PIN, 6.35	
2-4	012060632	1	アナヒラ6X6	SET SCREW, SOCKET (FT) M6X6	
2-5	062350812	2	ナハコ3.5X8	SCREW, PAN M3.5X8	
2-6	S39795001	1	ワイヤトリツケイタ	WIRE SETTING PLATE	
2-7	S21314001	1	フレキシブルワイヤクミ	FLEXIBLE WIRE ASSY	
2-8	S23774001	1	ダンネジ3.5	SHOULDER SCREW, M3.5	
2-9	S21315001	1	スタツトM4	STUD, M4	
2-10	021400432	1	2シユナツト4	NUT, 2 M4	
2-11	S21316001	1	ワイヤストッパ	WIRE STOPPER	
2-12	012400432	1	アナヒラ4X4	SET SCREW, SOCKET (FT) M4X4	
2-13	S23349001	1	レハチヨウセツイタ	LEVER ADJUSTING PLATE	
2-14	060400812	2	ハインドM4X8	SCREW, BIND M4X8	
2-15	S39796001	1	スペーサ	SPACER	
2-16	060400812	1	ハインドM4X8	SCREW, BIND M4X8	
2-17	011502012	2	トメネジ5X20ヒラ	SET SCREW, (FT) M5X20	
2-18	021500312	2	3シユナツト5	NUT, 3 M5	

< 半沈用 / For Semi-submerged >

- 4420
- 4430
- 4620
- 4630
- 5420
- 5430
- 5620
- 5630

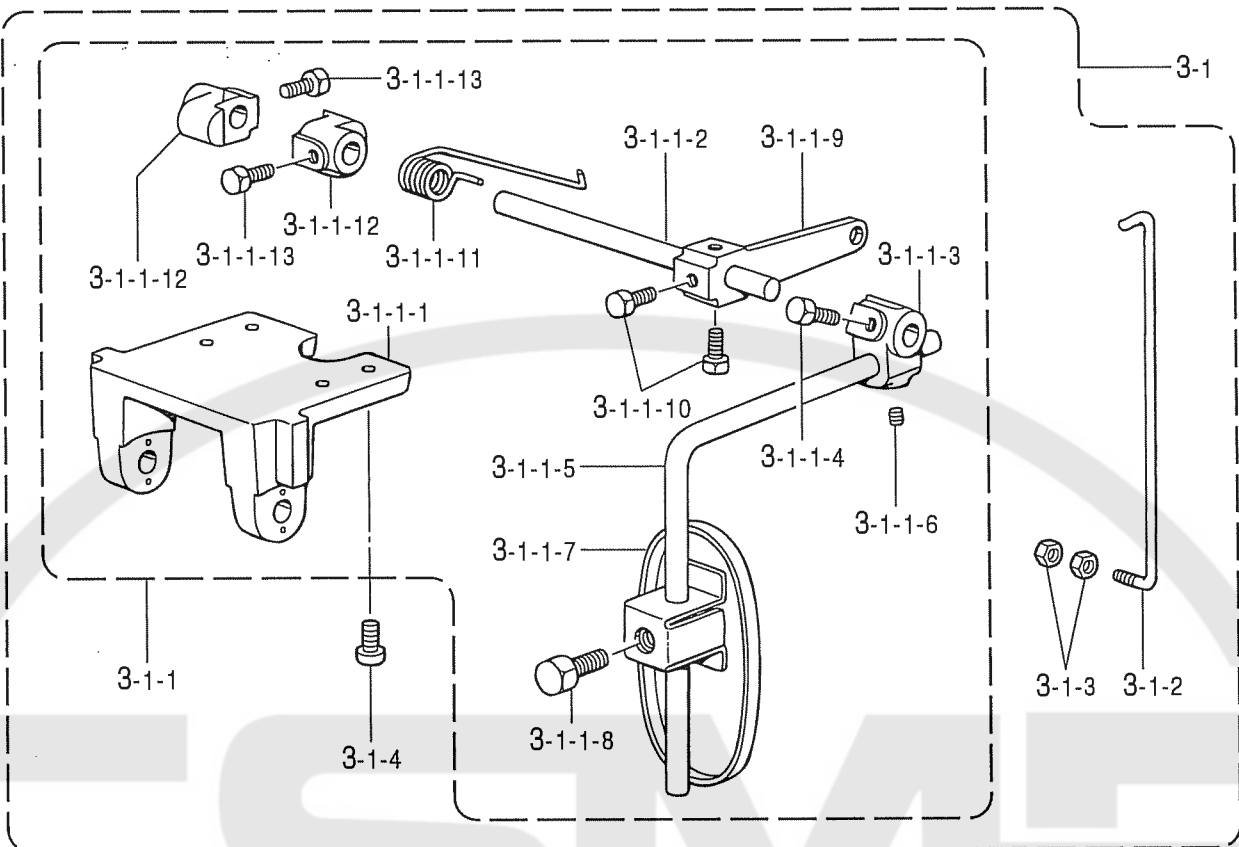

< 全沈用 / For Fully-submerged >

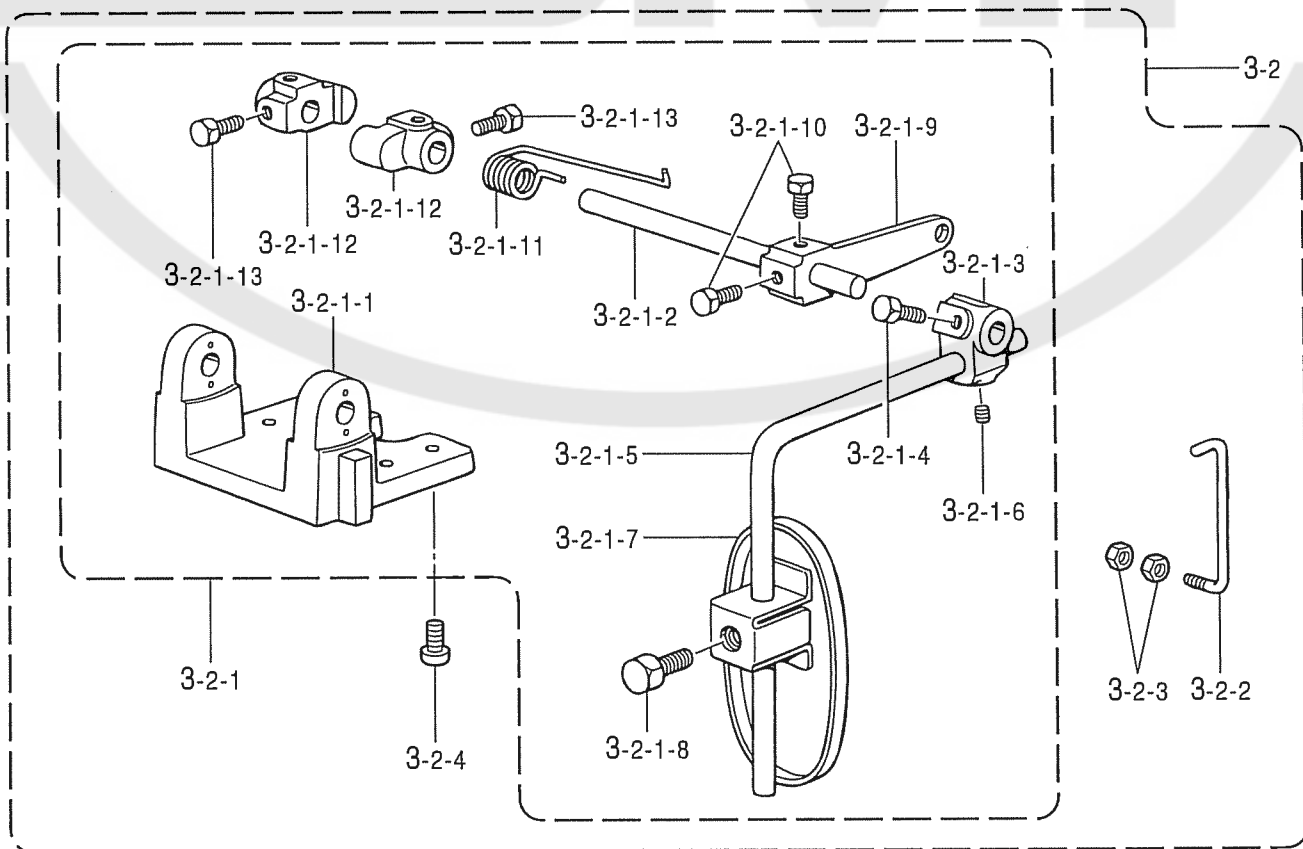

Q2. ラフラー装置関係 / Ruffling attachment

REF.NO	CODE	QTY	ヒンメイ	NAME OF PARTS	RM
			<半沈用>	<For Semi-submerged>	
3-1	S30135101	1	サトウチヨウセツセツ	DIFFERENTIAL ADJUSTING SET	
3-1-1	S21373101	1	サトウチヨウセツソウチクミ	DIFFERENTIAL FEED ADJUSTER	
3-1-1-1	155197101	1	ヒサアテヨコシクウケ	KNEE LIFTER SHAFT BRACKET	
3-1-1-2	S21375001	1	ヨコシク	KNEE LIFTER SHAFT	
3-1-1-3	155199101	1	ヒサアテツキテ	BRACKET, KNEE LIFTER	
3-1-1-4	017781412	2	ボルト6.35X14	BOLT, SM6.35X14	
3-1-1-5	148797001	1	ヒサアケタテシクス	KNEE LIFTER BAR, S	
3-1-1-6	014780622	1	アトメネシ6.35クホミ	SET SCREW, SOCKET (CP) SM6.35	
3-1-1-7	148798109	1	ヒサアテL	KNEE LIFTER PLATE, L	
3-1-1-8	017081606	1	ボルト8X16	BOLT, M8X16	
3-1-1-9	S21376001	1	ヒサアテレハ	KNEE LIFTER LEVER	
3-1-1-10	017781412	2	ボルト6.35X14	BOLT, SM6.35X14	
3-1-1-11	S21377001	1	ヒサアテレハハネ	SPRING, TWIST	
3-1-1-12	S21378001	2	ヨコシクメク	COLLAR	
3-1-1-13	017781412	4	ボルト6.35X14	BOLT, SM6.35X14	
3-1-2	S21379001	1	ヒサアテリンク	CONNECTING BAR	
3-1-3	021400202	2	2シユナツト4	NUT, 2 M4	
3-1-4	062401012	4	ナハコM4X10	SCREW, PAN M4X10	
			<全沈用>	<For Fully-submerged>	
3-2	S30135102	1	サトウチヨウセツセツ	DIF.ADJUSTING SET, FULL	
3-2-1	S21380101	1	サトウチヨウセツソウチクミ	DIFFERENTIAL FEED ADJUSTER	
3-2-1-1	155197101	1	ヒサアテヨコシクウケ	KNEE LIFTER SHAFT BRACKET	
3-2-1-2	S21375001	1	ヨコシク	KNEE LIFTER SHAFT	
3-2-1-3	155199101	1	ヒサアテツキテ	BRACKET, KNEE LIFTER	
3-2-1-4	017781412	2	ボルト6.35X14	BOLT, SM6.35X14	
3-2-1-5	148797001	1	ヒサアケタテシクス	KNEE LIFTER BAR, S	
3-2-1-6	014780622	1	アトメネシ6.35クホミ	SET SCREW, SOCKET (CP) SM6.35	
3-2-1-7	148798109	1	ヒサアテL	KNEE LIFTER PLATE, L	
3-2-1-8	017081606	1	ボルト8X16	BOLT, M8X16	
3-2-1-9	S21376001	1	ヒサアテレハ	KNEE LIFTER LEVER	
3-2-1-10	017781412	2	ボルト6.35X14	BOLT, SM6.35X14	
3-2-1-11	S21377001	1	ヒサアテレハハネ	SPRING, TWIST	
3-2-1-12	S21378001	2	ヨコシクメク	COLLAR	
3-2-1-13	017781412	4	ボルト6.35X14	BOLT, SM6.35X14	
3-2-2	S21381001	1	ヒサアテリンク	CONNECTING BAR	
3-2-3	021400202	2	2シユナツト4	NUT, 2 M4	
3-2-4	062401012	4	ナハコM4X10	SCREW, PAN M4X10	

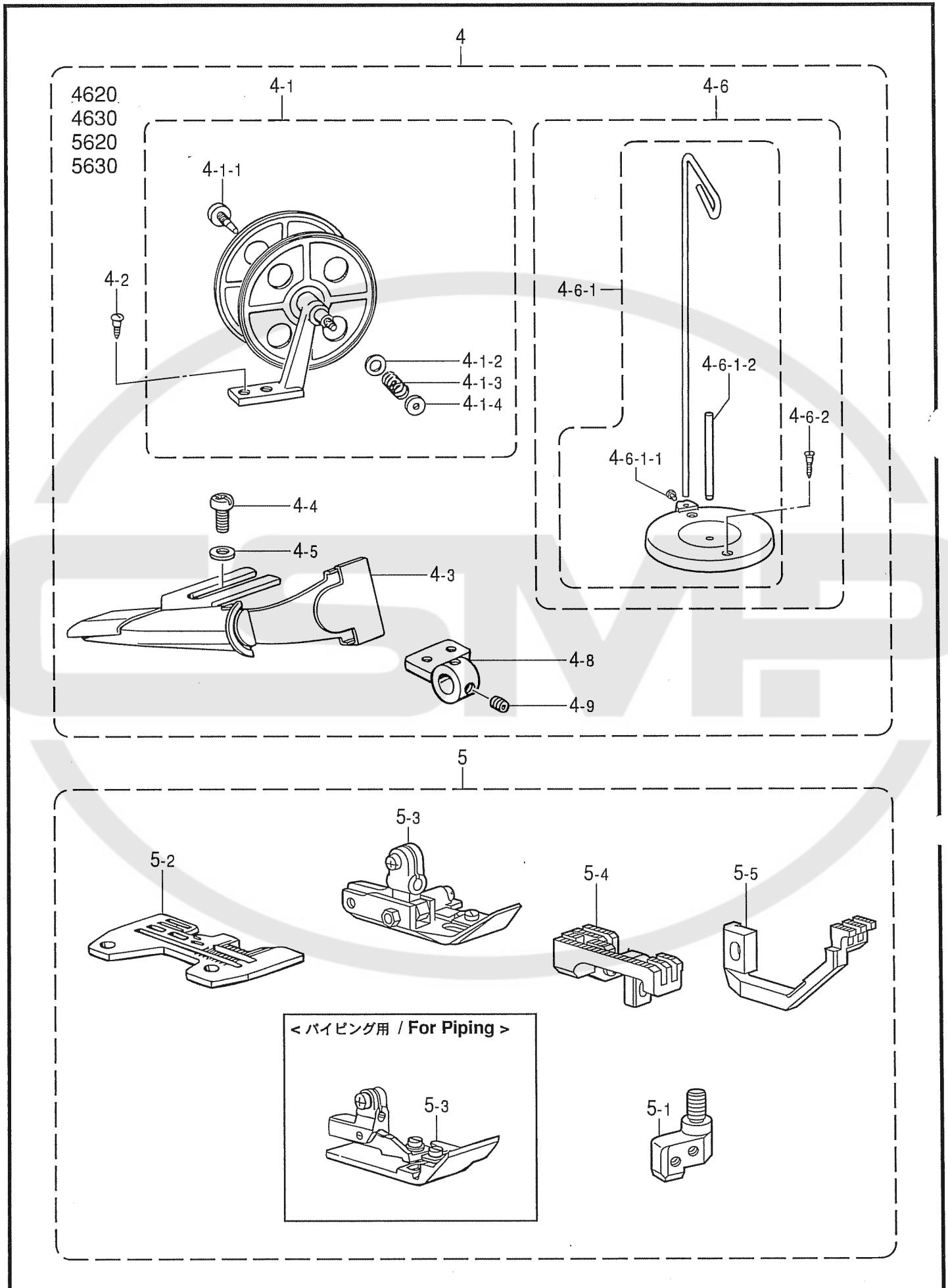

Q3. ラフラー装置関係 / Ruffling attachment

REF.NO	CODE	Q'TY	ヒンメイ	NAME OF PARTS	RM
4	S30303001	1	パイピングパーツ	PIPING PARTS ASSY	
4-1	143767102	1	テープワインダー	TAPE WINDER ASSY	
4-1-1	143980001	1	ツミネジ	SCREW	
4-1-2	108494001	1	ワッシャー	WASHER	
4-1-3	108495001	1	テープワインダー用スプリング	SPRING, COMPRESSION	
4-1-4	100136001	1	テンションナット	NUT, TENSION	
4-2	101118001	2	丸頭ネジ M4.5X20	WOOD SCREW, ROUND M4.5X20	
4-3	S21318000	1	ラッパ	LAPPER ASSY	
4-4	062400812	2	六角ネジ M4X8	SCREW, PAN M4X8	
4-5	025040232	2	平ワッシャー M4	WASHER, PLAIN M 4	
4-6	S20130009	1	コットンスタンド	COTTON STAND ASSY, W/SCREW	
4-6-1	S20131009	1	コットンスタンド	COTTON STAND ASSY	
4-6-1-1	S20134001	1	ネジ W4.76-24X10	SCREW, W4.76-24X10	
4-6-1-2	S20135001	1	スプールピン	SPOOL PIN	
4-6-2	034422006	2	平頭ネジ M4.1X20	WOOD SCREW, FLAT 2 M4.1X20	
4-8	S25019001	1	ラッパベース	LAPPER BASE	
4-9	S23651002	2	六角ネジ M6X5	SET SCREW, SOCKET (FT) M6X5	
5	*	1	ラッパゲージ	RUFFLER GAUGE ASSY	
5	*	1	パイピング用ラッパゲージ	<For Piping> PIPING RUFFLER GAUGE ASSY	
5-1	*	1	針止め	NEEDLE CLAMP ASSY	
5-2	*	1	針板	NEEDLE PLATE	
5-3	*	1	プレス足	PRESSER FOOT ASSY	
5-4	*	1	メインフィーディングドッグ	MAIN FEED DOG ASSY	
5-5	*	1	差動フィーディングドッグ	DIFFERENTIAL FEED DOG	

	REF. NO.	4420-24,5420		4420-25,5420		4420-34,5420	
		半沈 Semi- submerged	全沈 Fully- submerged	半沈 Semi- submerged	全沈 Fully- submerged	半沈 Semi- submerged	全沈 Fully- submerged
ラッパシヨウセット/Ruffler set		S43539001	S43541001	S43539002	S43541002	S43539003	S43541003
ラッパ	1	S30304001	←	←	←	←	←
ラッパ用サエレンドウ	2	S43530001	←	←	←	←	←
サドウチョウセツセット /Differential adjusting set	3	S30135101	S30135102	S30135101	S30135102	S30135101	S30135102
ラッパゲージ	5	S30296001	←	S30296002	←	S30296003	←

	REF. NO.	4420-35,5420		4430-55,5430		4430-56,5430	
		半沈 Semi- submerged	全沈 Fully- submerged	半沈 Semi- submerged	全沈 Fully- submerged	半沈 Semi- submerged	全沈 Fully- submerged
ラッパシヨウセット/Ruffler set		S43539004	S43541004	S43539005	S43541005	S43539006	S43541006
ラッパ	1	S30304001	←	←	←	←	←
ラッパ用サエレンドウ	2	S43530001	←	←	←	←	←
サドウチョウセツセット /Differential adjusting set	3	S30135101	S30135102	S30135101	S30135102	S30135101	S30135102
ラッパゲージ	5	S30296004	←	S30296005	←	S30296006	←

	REF. NO.	4620-35,5620		4630-55,5630		4630-56,5630	
		半沈 Semi- submerged	全沈 Fully- submerged	半沈 Semi- submerged	全沈 Fully- submerged	半沈 Semi- submerged	全沈 Fully- submerged
P.ラッパシヨウセット/Piping ruffler set		S43540004	S43542004	S43540005	S43542005	S43540006	S43542006
ラッパ	1	S30304001	←	←	←	←	←
ラッパ用サエレンドウ	2	S43530001	←	←	←	←	←
サドウチョウセツセット /Differential adjusting set	3	S30135101	S30135102	S30135101	S30135102	S30135101	S30135102
パイピングパーツ	4	S30303001	←	←	←	←	←
P.ラッパゲージ/Piping ruffler gauge assy	5	S30297004	←	S30297002	←	S30297006	←

Z1. 付属品関係 / Accessories

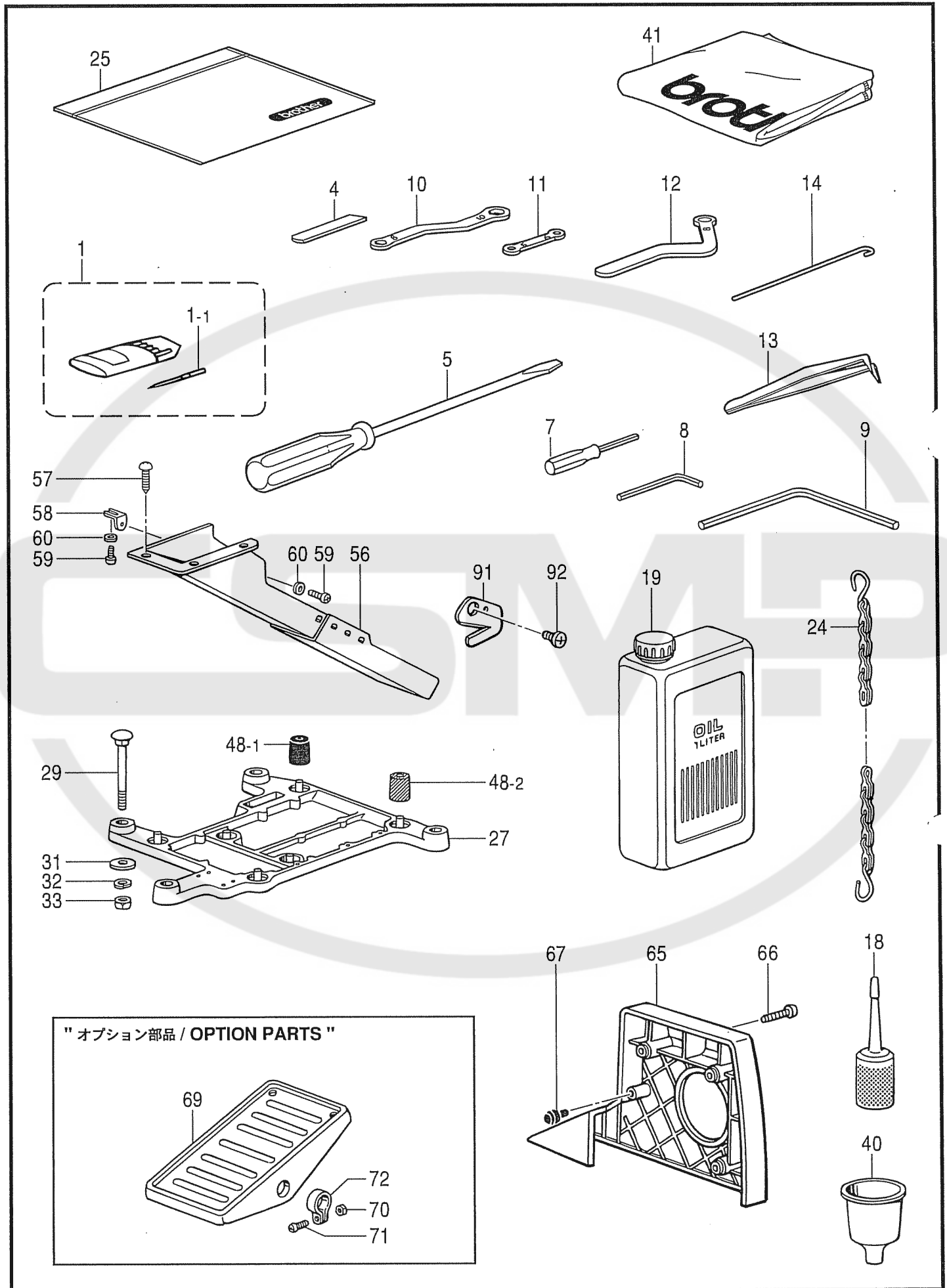

Z1. 付属品関係 / Accessories









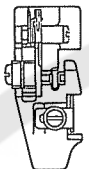
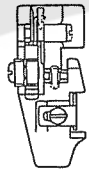
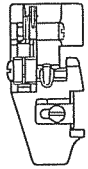
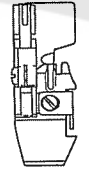
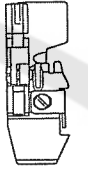
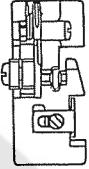

REF.NO	CODE	QTY	ヒンメイ	NAME OF PARTS	RM
1	*	2	ミシンハリクミ	NEEDLE ASSY	
1-1	*	8	ミシンハリ	NEEDLE	
4	*	1	シタメス	LOWER KNIFE, T=1.5	
5	101572101	1	ネジ マワシ5.5X190	SCREW DRIVER, 5.5X190	
7	S01943001	1	6カクホ ウネジ マワシ1.6	SCREW DRIVER, HEX. 1.6	
8	142002001	1	6カクホ ウスハ°ナ2	HEXAGONAL WRENCH, 2	
9	149570001	1	6カクホ ウスハ°ナ5	HEXAGONAL WRENCH, 5	
10	S23356001	1	メガ ネレンチ8X10	DOUBLE WRENCH, 8X10	
11	S46907001	1	メガ ネレンチ5X6	WRENCH, 5X6	
12	S20723001	1	メガ ネレンチ8	DOUBLE WRENCH, 8	
13	117466000	1	ピンセット	PINCETTE	
14	S24473000	1	イトボシ	THREADER	
18	S06701000	1	ホリオリークミ	POLY OILER ASSY	
19	S55666002	1	オイルタンクBクミ	OIL TANK ASSY, B	
24	142262001	1	クサリFクミ	CHAIN ASSY, F	
25	122991001	1	フジクヒホリフクロ	ACCESSORY BAG	
27	S20718000	1	トウフウク	HEAD PLATE	
29	S35997001	4	カクネホルト8X85	BOLT, M8X85	
31	213650001	4	ワ2.3X8.5X38ST	WASHER, 2.3X8.5X38ST	
32	028080242	4	ハネサカネ2-8	WASHER, SPRING 2-8	
33	021080106	4	ナツト1シ18	NUT, 1 M8	
40	S20769000	1	シヨコ	FUNNEL	
41	144225002	1	トウフウカバー	HEAD COVER	
48-1	147919051	1	ホウシンゴム	RUBBER CUSHION	
48-2	147919052	3	ホウシンゴム	RUBBER CUSHION	
56	183797009	1	ダスターシュートクミ	DUSTER CHUTE ASSY	
57	031411304	3	マルモクネジ4.1X13	WOOD SCREW, ROUND M4.1X13	
58	S23353001	1	ダスターシュートササIS	DUSTER SHOOT SUPPORT, S	
59	062400612	2	ナヘコM4X6	SCREW, PAN M4X6	
60	025040332	2	ヒラサカネ4	WASHER, PLAIN L 4	
65	S38302020	1	ベルトカバー	BELT COVER	
66	062061412	3	ナヘコM6X14	SCREW, PAN M6X14	
67	S20412000	1	ゴムセン3.7	RUBBER CAP, 3.7	
91	S20118151	1	カラヌイメス	TRIMMING KNIFE	
92	060300512	1	ハイントM3X5	SCREW, BIND M3X5	
69	147893009	1	”オプション部品” オサアゲフミタ	"OPTION PARTS" TREADLE PEDAL	
70	021400106	2	ナツト1シ14	NUT, 1 M4	
71	062401406	2	ナヘコM4X14	SCREW, PAN M4X14	
72	116016001	2	ハタルトメ	PEDAL STOPPER	

Z2. 付属品関係 / Accessories



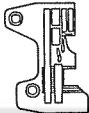
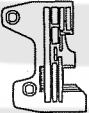
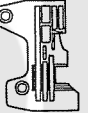
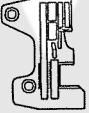
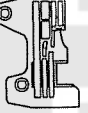
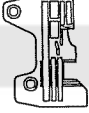
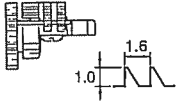
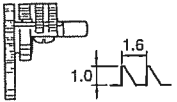
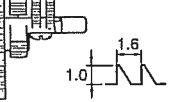
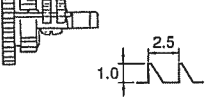
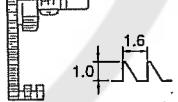
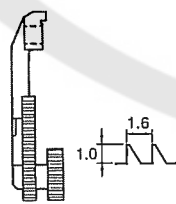
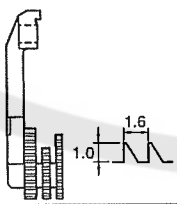
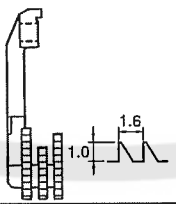
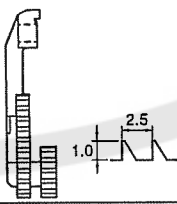
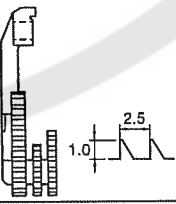
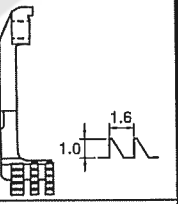

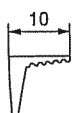
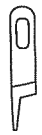
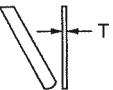
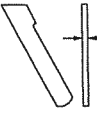



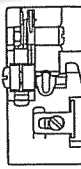
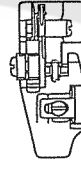
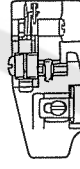
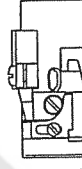

REF.NO	CODE	QTY	ヒンメイ	NAME OF PARTS	RM
42	S45953001	1	イトタテタ`イクミ5DTHF	COTTON STAND ASSY, 5DTHF	
42-1	150172023	1	コラム`イ`	COLUMN PIPE	
42-2	S36064021	1	コラム`イ`D	COLUMN PIPE, D	
42-3	150206022	1	ヒラサ`カ`ネ16	WASHER, PLAIN 16	
42-4	S36062021	1	6カナツトM16	NUT, M16	
42-5	S35635020	2	コラムキヤツフ`	COLUMN CAP	
42-6	150173023	1	コラムジ`ョイント	COLUMN JOINT	
42-7	S35826021	2	ナ`コ5X14	SCREW, PAN M5X14	
42-8	S35827021	2	1シユナツト5	NUT, 1 M5	
42-9	S02778022	1	スプ`-ルホルタ`-2	SPOOL HOLDER, 2	
42-10	S45970001	1	スレツト`ハンカ`-クミ2	THREAD HANGER ASSY, 2	
42-10-1	S35832021	1	ナ`サ`クミ5X14A	SCREW, PAN (S/P WASHER) M5X14	
42-10-2	S35827021	1	1シユナツト5	NUT, 1 M5	
42-11	S02779009	1	スプ`-ルホルタ`-3	SPOOL HOLDER, 3	
42-12	S35831021	1	ナ`サ`クミ5X30A	SCREW, PAN (S/P WASHER) M5X30	
42-13	S35827021	1	1シユナツト5	NUT, 1 M5	
42-14	S45964001	1	スレツトハンカ`-クミ3	THREAD HANGER ASSY, 3	
42-14-1	S35832021	1	ナ`サ`クミ5X14A	SCREW, PAN (S/P WASHER) M5X14	
42-14-2	S35827021	1	1シユナツト5	NUT, 1 M5	
42-15	150179022	2	スプ`-ルシ`クB	SPOOL SHAFT, B	
42-16	028050246	2	ハ`ネサ`カ`ネ2-5	WASHER, SPRING 2-5	
42-17	S35827021	2	1シユナツト5	NUT, 1 M5	
42-18	126863021	2	スプ`-ルクツシヨ`	SPOOL CUSHION	
42-19	150180021	2	ウケサ`ラ	SPOOL STAND BASE	
42-20	150182020	2	スプ`-ルマツト	SPOOL MAT	
42-21	150185009	1	イトアンナイホルタ`-	THREAD GUIDE HOLDER	
42-22	S35831021	1	ナ`サ`クミ5X30A	SCREW, PAN (S/P WASHER) M5X30	
42-23	S35827021	1	1シユナツト5	NUT, 1 M5	
42-24	S04109001	1	イトアンナイササ`イホ`ウ	SUPPORT BAR, ;TR-GUIDE	
42-25	S45961001	1	ササ`イホ`ウツキ`テ	JOINT	
42-26	012060632	2	ア`ヒラ6X6	SET SCREW, SOCKET (FT) M6X6	
42-27	142999101	1	イトアンナイ5	THREAD GUIDE, 5	
42-28	150188009	1	スプ`-ルホルタ`-ササ`IA	SPOOL HOLDER SUPPORT, A	
42-29	S35826021	1	ナ`コ5X14	SCREW, PAN M5X14	
42-30	S35827021	1	1シユナツト5	NUT, 1 M5	
42-31	031452206	1	マルモク45X22	WOOD SCREW, ROUND M4.5X22	
42	S45954001	1	<6本糸用> イトタテタ`イクミ6DTHF	<For "6 Threads"> COTTON STAND ASSY, 6DTHF	
42-27	S02783001	1	イトアンナイ6	THREAD GUIDE, 6	
42-32	150194009	1	スプ`-ルホルタ`-ササ`IB	SPOOL HOLDER SUPPORT, B	
64-1	183798001	1	" オフ`シヨ`ン部品" フルサフ`マ`シ`セツト	"OPTION PARTS" FULL SUBMERGED SET	
64-1	S20721001	1	トウフ`ウケササ`E	HEAD PLATE SUPPORT	
64-2	153318201	4	カクネマルアタマホ`ルト	BOLT	
64-3	S35997001	1	カクネホ`ルト8X85	BOLT, M8X85	
64-4	S36007001	1	カクネホ`ルト8X55	BOLT, M8X55	
64-5	017085502	1	ホ`ルトM8X55	BOLT, M8X55	
64-6	025080236	11	ヒラサ`カ`ネユウ8	WASHER, PLAIN M 8	
64-7	028080242	7	ハ`ネサ`カ`ネ2-8	WASHER, SPRING 2-8	
64-8	021080106	15	ナツト1シユ	NUT, 1 M8	
64-9	213650001	8	ワ2. 3X8. 5X38ST	WASHER, 2.3X8.5X38ST	
64-10	S20722001	1	タ`スター`シユトササ`IL	DUSTER SHOOT SUPPORT, L	
64-11	060400812	2	ハ`イント`M4X8	SCREW, BIND M4X8	
64-12	060400812	3	ハ`イント`M4X8	SCREW, BIND M4X8	

Ga1 . ゲージ部品一覧表 / Gauge parts List



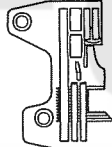
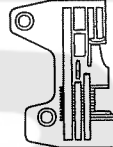
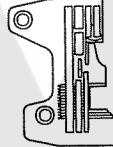
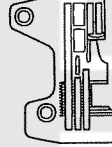
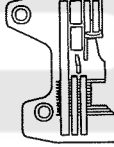
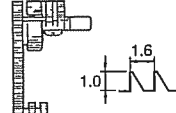
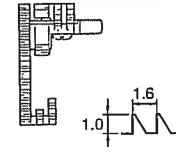
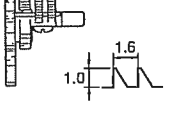
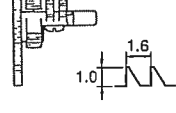
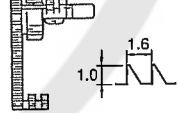
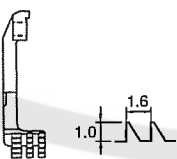
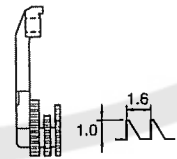
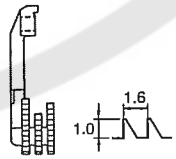
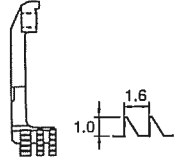

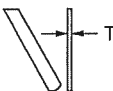

下の表は サブクラスの番号順に 並べてあります

用途 Application	一般地縫用 (薄) Thin 4本糸 4 Threads	一般地縫用 (薄・中厚) Thin Medium 4本糸 4 Threads	一般地縫用 (中厚・厚) Thin Medium 4本糸 4 Threads	極厚物用 Extra Heavy 4本糸 4 Threads		ラフラー用 Ruffling 4本糸 4 Threads
サブクラス Sub-Class	4010-22-S2F -23-S2F -24-S2F -25-S2F	4020-33-S3F -34-S3F -35-S3F -36-H3F -37-H3F	4030-54-S2F -55-S2F -56-H3F -57-H3F	4050-35-E2W	4050-55-E3W -56-E3W -57-E3W	4420-24-S3F -25-S3F
針巾 (mm) Needle Gauge	2	3	5	3	5	2
1 針 (個数) Needle (Qty)	151474-011 (2)	151474-014 (2)	151474-016 (2)	151474-018 (2)		151474-014 (2)
2 押工組 Presser Foot Assy (押工 F (Presser Foot .F))	S19304-101 (S19312-001) 	S19313-201 (S30971-001) 	S19317-101 (S19312-001) 	S25557-001 (S19340-001) 	S19334-001 (S19340-001) 	S25548-101 (S19325-001) 
3 針止め組 Needle Clamp Assy	S29146-001 	S20404-001 	S20406-001 	S29631-001 	S21104-001 	S29146-001 
4 針板 Needle Plate	S25194-001 (2) S25195-001 (3) S19174-001 (4) S19175-001 (5) 	S20234-001 (3) S20235-001 (4) S20236-001 (5) S35651-001 (6) S25196-001 (7) 	S20231-001 (4) S20232-001 (5) S20233-001 (6) S25197-001 (7) 	S25200-001 (3) S25201-001 (5) 	S19185-001 (5) S19186-001 (6) S19187-001 (7) 	S25198-001 (4) S25199-001 (5) 
5 主送り歯組 Main Feed Dog Assy (主送り歯 (Main Feed Dog) 補助送り歯 (Chain Feed Dog))	S19221-201 (S19222-201) (S33172-001) L 	S20241-101 (S20242-101) (S20243-101) H 	S20239-101 (S20240-101) (S19223-101) F 	S19228-101 (S19229-001) (S19223-101) F 	S19224-201 (S19225-201) (S33172-001) L 	
6 差動送り歯 Differential Feed Dog	S19245-001 	S20245-001 	S20244-001 	S25566-001 	S19247-001 	S19246-001 
7 上メス Upper Knife	上メス Upper knife 144074-350 			角メス Angle knife S20898-101 		上メス Upper knife 144074-350 
8 下メス Lower Knife 	(2) S20899-001 (T=1.0) (3, 4, 5) S20582-001 (T=1.5)	(3) S20899-001 (T=1.0) (4, 5, 6, 7) S20582-001 (T=1.5)	S20582-001 (T=1.5)	S20583-001 (T=1.5) 		S20582-001 (T=1.5)
9 上ルーバ Over Looper 	S20421-001 L	S20423-001 (3,4,5) M S20421-001 (6, 7) L	S20423-001 (4, 5) M S20421-001 (6, 7) L	S20429-001 Q		S20423-001 M

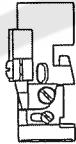
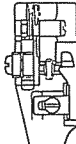
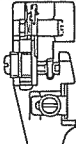
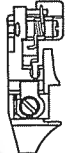
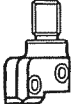

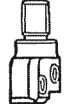
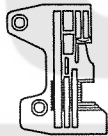
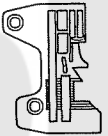
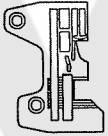
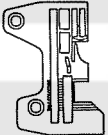
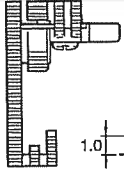
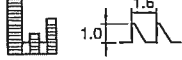
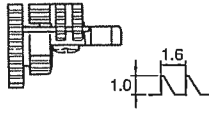
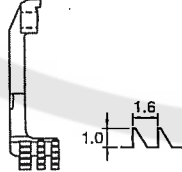
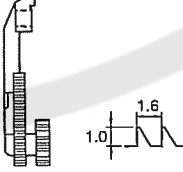

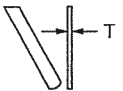



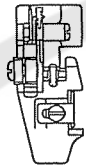
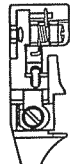
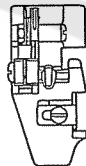
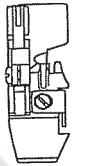
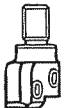

Ga2 . ゲージ部品一覧表 / Gauge parts List

用途 Application	ラフラー用 Ruffling 4本糸 4 Threads		テープ用 Taping 4本糸 4 Threads		パイピング ラフラー用 Ruffling W / Piping 4本糸 4 Threads
サブクラス Sub-Class	4420-34-S3F -35-S3F	4430-55-S3F -56-H3F	4520-34-S3F -35-S3F	4530-54-S3F -55-S3F -56-H3F	4620-35-H3F
針巾 (mm) Needle Gauge	3	5	3	5	3
1 針 (個数) Needle (Q'ty)	151474-014 (2)		151474-014 (2)	151474-016 (2)	151474-014 (2)
2 押工組 Presser Foot Assy (押工 F (Presser Foot .F)	S19321-101 (S19325-001) 	S19326-101 (S19325-001) 	S19330-201 (S30971-001) 	S20882-201 (S30971-001) 	S25550-001 (S25553-001) 
針止め組 Needle Clamp Assy	S20404-001 	S20406-001 	S20404-001 	S20406-001 	S20404-001 
4 針板 Needle Plate	S19497-001 (4) S19182-001 (5) 	S19183-001 (5) S19184-001 (6) 	S20235-001 (4) S20236-001 (5) 	S20231-001 (4) S20232-001 (5) S20233-001 (6) 	S19182-001 (5) 
5 主送り歯組 Main Feed Dog Assy (主送り歯 (Main Feed Dog) (補助送り歯 (Chain Feed Dog)	S19224-201 (S19225-201) (S33172-001) L 	S19226-101 (5) (S19227-101) (S19223-101) F S19224-201 (6) (S19225-201) (S33172-101) L 	S20241-101 (S20242-101) (S20243-101) H 	S20239-101 (S20240-101) (S19223-101) F 	S19224-201 (S19225-201) (S33172-001) L 
6 差動送り歯 Differential Feed Dog	S19246-001 	S20245-001 	S20244-001 	S19246-001 	
7 上メス Upper Knife	上メス Upper knife 144074-350 				
8 下メス Lower Knife 	S20582-001 (T=1.5)				
9 上ルーパ Over Looper 	S20423-001 M		S20423-001 (4, 5) M S20421-001 (6) L		S20423-001 M

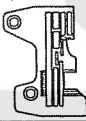

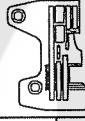
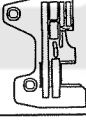
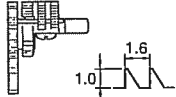
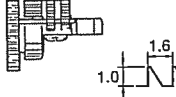
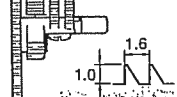
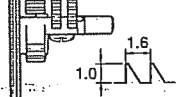
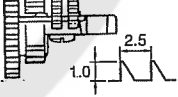
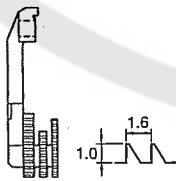
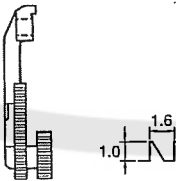
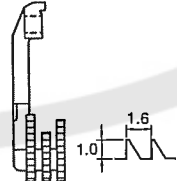
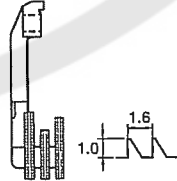
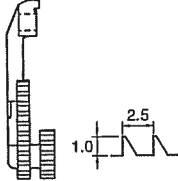

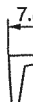
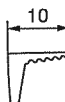
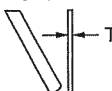
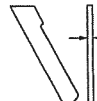



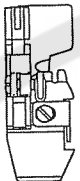
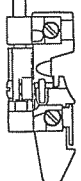
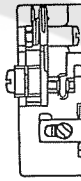
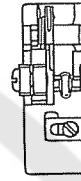
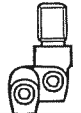
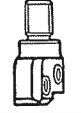

Ga3 . ゲージ部品一覧表 / Gauge parts List

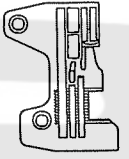
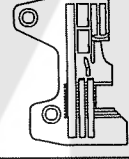
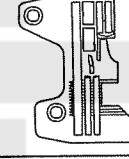
用途 Application	パイピングラフラー用 Ruffling W / Piping 4本糸 4 Threads	バイディング用 Binding 4本糸 4 Threads	一般地縫用 (薄) Thin 5本糸 5 Threads	一般地縫用 (薄) Thin (小回り用) (For small type)
サブクラス Sub-Class	4630-55-S3F -56-H3F	4720-34-S2F -35-S2F	5010-22-S2F -23-S2F -24-S2F -25-S2F	5011-22-S2F -23-S2F -24-S2F -25-S2F
針巾 (mm) Needle Gauge	5	3	2	
1 針 (個数) Needle (Q'ty)	151474-014 (2)		151474-011 (2)	
2 押工組 Presser Foot Assy (押工 F Presser Foot .F)	S25555-001 (S25553-001) 	S25560-101 (S19312-001) 	S19304-101 (S19312-001) 	S30586-101 (3, 4) ツメ Stitch Tongue S30588-001 S30592-101 (5, 6) ツメ Stitch Tongue S30593-001 
3 針止め組 Needle Clamp Assy	S20406-001 	S20404-001 	S29146-001 	
4 針板 Needle Plate	S19183-001 (5) S19184-001 (6) 	S25202-001 (4) S25203-001 (5) 	S25194-001 (2) S25195-001 (3) S19174-001 (4) S19175-001 (5) 	S25194-001 (2) S25195-001 (3) S19174-001 (4) S19175-001 (5) 
5 主送り歯組 Main Feed Dog Assy (主送り歯 Main Feed Dog) (補助送り歯 Chain Feed Dog)	S19226-101 (5) (S19227-101) (S19223-101) F  S19224-201 (6) (S19225-201) (S33172-001) L 	S19221-201 (S19222-201) (S33172-001) L 		
6 差動送り歯 Differential Feed Dog	S19246-001 	S19245-001 		
7 上メス Upper Knife	上メス Upper knife 144074-350			
8 下メス Lower Knife 	S20582-001 (T=1.5)		(2) S20899-001 (T=1.0) (3, 4, 5) S20582-001 (T=1.5)	
9 上ルーバ Over Looper 	S20423-001 M		S20422-001 A	





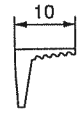
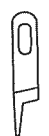
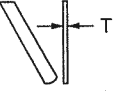
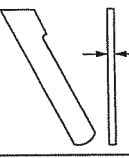
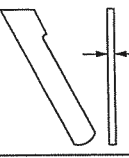
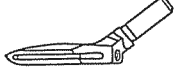

Ga4 . ゲージ部品一覧表 / Gauge parts List

用途 Application	一般地縫用 (薄・中厚) Thin Medium		一般地縫用 (中厚・厚) Medium Thick		極厚物用 Extra Heavy
	5本糸 5 Threads	(小回り用) (For small type)	5本糸 5 Threads		5本糸 5 Threads
サブクラス Sub-Class	5020-33-S3F -34-S3F -35-S3F -36-H3F -37-H3F	5021-33-S2F -34-S2F -35-S2F	5030-54-S3F -55-S3F -56-H3F -57-H3F	5033-54-H3A -55-H3A -56-H3A -57-H3A	5050-33-E2W -35-E2W
針巾 (mm) Needle Gauge	3	3	5		3
1針 (個数) Needle (Q'ty)	151474-014 (2)	151474-014 (2)	151474-016 (2)		151474-018 (2)
2 押工組 Presser Foot Assy (押工 F Presser Foot .F)	S19313-201 (S30971-001) 	S30594-101 (3, 4) ツメ Stitch Tongue S30588-001 S30597-101 (5, 6) ツメ Stitch Tongue S30593-001 	S19317-101 (S19312-001) 	S25557-001 (S19340-001) 	
針止め組 Needle Clamp Assy	S20404-001 	S20404-001 	S20406-001 	S21104-001 	S29631-001 
4 針板 Needle Plate	S20234-001 (3) S20235-001 (4) S20236-001 (5) S35651-001 (6) S25196-001 (7) 	S19176-001 (3) S19177-001 (4) S19178-001 (5) 	S20231-001 (4) S20232-001 (5) S20233-001 (6) S25197-001 (7) 	S25200-001 (3) S25201-001 (5) 	
5 主送り歯組 Main Feed Dog Assy (主送り歯 Main Feed Dog) (補助送り歯 Main Feed Dog)	S20241-101 (S20242-101) (S20243-101) H 	S19221-201 (S19222-201) (S33172-001) L 	S20239-101 (S20240-101) (S19223-101) F 	S35840-001 (S35991-001) (S19223-101) F 	S19228-101 (S19229-001) (S19223-101) F 
6 差動送り歯 Differential Feed Dog	S20245-001 	S19245-001 	S20244-001 	S35992-001 	S25566-001 
7 上メス Upper Knife		上メス Upper knife 144074-350 		角メス Angle knife S20896-101 	角メス Angle knife S20898-101 
8 下メス Lower Knife 	(3) S20899-001 (4, 5, 6, 7) S20582-001 (T=1.5)	(3) S20899-001 (T=1.0) (4, 5, 6, 7) S20582-001 (T=1.5)	S20582-001 (T=1.5)		S20583-001 (T=1.5) 
9 上ルーバ Over Looper 	S20424-001 (3,4,5) B S20428-001 (6,7) C	S20424-001 B	S20424-001 (4,5) B S20428-001 (6,7) C	S20428-001 C	S20438-101 G

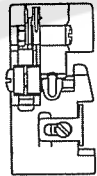
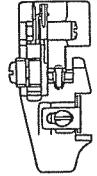
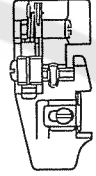
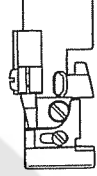
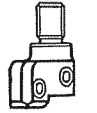
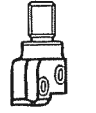
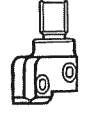
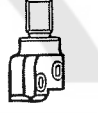
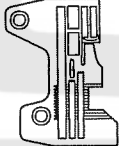
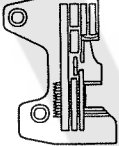
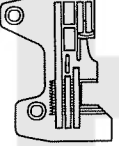
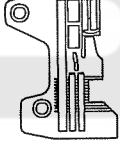
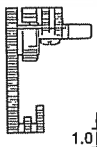

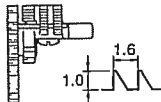
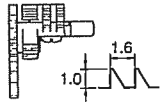
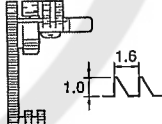
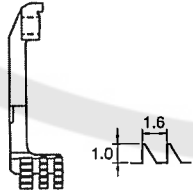
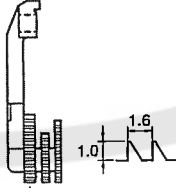
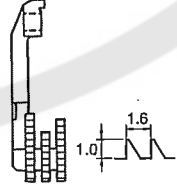
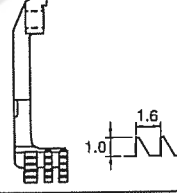

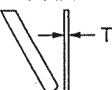





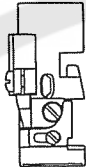
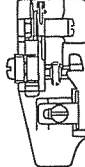
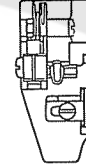
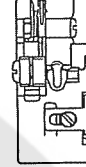
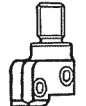
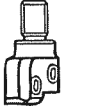

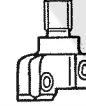
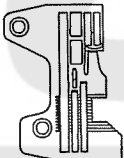
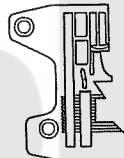
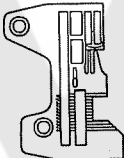
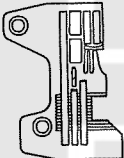
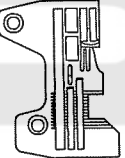
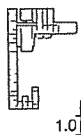
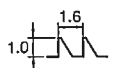
Ga5 . ゲージ部品一覧表 / Gauge parts List

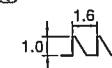
用途 Application	極厚物用 Extra Heavy (縦ポケット用) (For Vertical Pocket)		ラフラー用 Ruffling	
	5本糸 5 Threads		5本糸 5 Threads	
サブクラス Sub-Class	5050-55-E3W -56-E3W -57-E3W	4050-55-E3W -56-E3W -57-E3W	5420-24-S3F -25-S3F	5420-34-S3F -35-S3F
針巾 (mm) Needle Gauge	5		2	3
1 針 Needle	151474-018 (2)		151474-014 (2)	
2 押工組 Presser Foot Assy (ツメ (Stitch Tongue))	S19334-001 (S19340-001) 	S30525-001 (S30532-001) 	S25548-101 (S19325-001) 	S19321-101 (S19325-001) 
3 針止め組 Needle Clamp Assy	S21104-001 		S29146-001 	S20404-001 
4 針板 Needle Plate	S19185-001 (5) S19186-001 (6) S19187-001 (7) 		S25198-001 (4) S25199-001 (5) 	S19497-001 (4) S19182-001 (5) 
5 主送り歯組 Main Feed Dog Assy (主送り歯 (Main Feed Dog) 補助送り歯 (Chain Feed Dog))	S19228-101 (S19229-001) (S19223-101)  1.0 2.5	S38595-001 (S38596-001) (S19223-101) F  1.0 2.5 オプション部品 Option parts ウェットスーツ用 For Wet suit S38597-001  1.0 2.5	S19224-201 (S19225-201) (S33172-001) L  1.0 1.6	
6 差動送り歯 Differential Feed Dog	S19247-001  1.0 2.5	S38597-001  1.0 2.5	S19246-001  1.0 1.6	
7 上メス Upper Knife	角メス Angle Knife S20898-101  10		上メス Upper Knife 144074-350 	
8 下メス Lower Knife 	S20583-001 (T=1.5)  T		S20582-001 (T=1.5)  T	
9 上ルーパ Over Looper 	S20438-101 G		S20424-001 B	

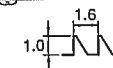

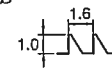
Ga6 . ゲージ部品一覧表 / Gauge parts List

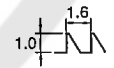
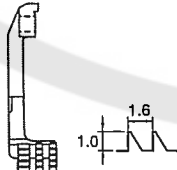
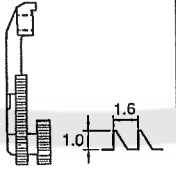
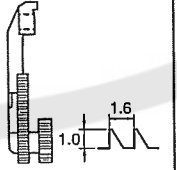
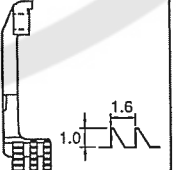
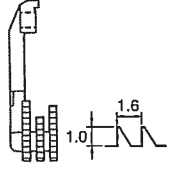
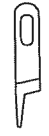
用途 Application	ラフラー用 Ruffling 5本糸 5 Threads	テープ用 Taping 5本糸 5 Threads		パイピングラフラー用 Ruffling W / Piping 5本糸 5 Threads
サブクラス Sub-Class	5430-55-S3F -56-H3F	5520-34-S3F -35-S3F	5530-54-S3F -55-S3F -56-H3F	5620-35-S3F
針巾 (mm) Needle Gauge	5	3	5	3
1 針 Needle	151474-014 (2)		151474-016 (2)	151474-014 (2)
2 押工組 Presser Foot Assy (ツメ Stitch Tongue)	S19326-101 (S19325-001) 	S19330-201 (S30971-001) 	S20882-201 (S30971-001) 	S25550-001 (S25553-001) 
針止め組 Needle Clamp Assy	S20406-001 	S20404-001 	S20406-001 	S20404-001 
4 針板 Needle Plate	S19183-001 (5) S19184-001 (6) 	S20235-001 (4) S20236-001 (5) 	S20231-001 (4) S20232-001 (5) S20233-001 (6) 	S19182-001 (5) 
5 主送り歯組 Main Feed Dog Assy (主送り歯 Main Feed Dog) (補助送り歯 Main Feed Dog)	S19226-101 (5) (S19227-101) (S19223-101) F  S19224-201 (6) (S19225-201) (S33172-101) L 	S20241-101 (S20242-101) (S20243-101) H 	S20239-101 (S20240-101) (S19223-101) F 	S19224-201 (S19225-201) (S33172-001) L 
6 差動送り歯 Differential Feed Dog	S19246-001 	S20245-001 	S20244-001 	S19246-001 
7 上メス Upper Knife	上メス Upper Knife 144074-350 			
8 下メス Lower Knife 	S20582-001 (T=1.5)			
9 上ルーバ Over Looper 	S20424-001 (5) B S20428-001 (6) C	S20424-001 B	S20424-001 (4,5) B S20428-001 (6) C	S20424-001 B

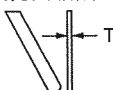
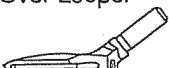
Ga7 . ゲージ部品一覧表 / Gauge parts List

用途 Application	パイピングラフラー用 Ruffling W / Piping 5本糸 5 Threads	バイディング用 Binding 5本糸 5 Threads	3本針 一般地縫用 (薄・中厚) 3 Needles Thin Medium		3本針 ラフラー用 3 Needles Ruffling
サブクラス Sub-Class	5630-55-S3F -56-H3F	5720-34-S2F -35-S2F	6030-B5-H2F	6030-B5-H3F	6430-B5-H3A
針巾 (mm) Needle Gauge	5	3	5, 2.2		
1 針 (個数) Needle (Q'ty)	151474-014 (2)	151474-014 (2)	151474-016 (3)		151474-014 (3)
2 押工組 Presser Foot Assy (押工 F Presser Foot .F)	S25555-001 (S25553-001) 	S25560-101 (S19312-001) 	S25562-101 (S19312-001) 	S31981-001 (S19325-001) 	
3 針止め組 Needle Clamp Assy	S20406-001 	S20404-001 	S29148-001 		S29148-001 
4 針板 Needle Plate	S19183-001 (5) S19184-001 (6) 	S25202-001 (4) S25203-001 (5) 	S25204-001 	S31975-001 	S31979-001 
5 主送り歯組 Main Feed Dog Assy (主送り歯 Main Feed Dog) (補助送り歯 Chain Feed Dog)	S19226-101 (5) (S19227-101) (S19223-101) F  S19224-201 (6) (S19225-201) (S33172-001) 1.0 1.6 	S19221-201 (S19222-201) (S33172-001) L  1.0 1.6 	S19221-201 (S19222-201) (S33172-001) L  1.0 1.6 	S20239-101 (S20240-101) (S19223-101) F  1.0 1.6 	S19226-101 (S19227-101) (S19223-101) F  1.0 1.6 
6 差動送り歯 Differential Feed Dog	S19246-001  1.0 1.6	S19245-001  1.0 1.6	S19245-001  1.0 1.6	S20244-001  1.0 1.6	S19246-001  1.0 1.6
7 上メス Upper Knife	上メス Upper knife 144074-350 				角メス Angle knife S20896-101 
8 下メス Lower Knife 	S20582-001 (T=1.5)		S20582-001 (T=1.5)		S20582-001 (T=1.5)
9 上ルーパ Over Looper 	S20424-001 (5) B S20428-001 (6) C	S20424-001 B	S20430-001 D		S20430-001 D

Wa. 警告ラベル / Warning labels

警告ラベル / Warning labels	品名 / Name of parts	Size(mm)	Code
	操作注意ラベル・和	40 X 64	S38350-001
	Label, operation Eng.	40 X 64	S38349-001
	アースマーク Mark, grounding	φ 12	S37060-001

878-N31-052

索引 / INDEX

CODE	REF.NO	page
004350812	G 31	16
011502012	Q1 2-17	36
012060632	A 43	2
	B 26	6
	B 25	6
	F1 25	12
	G 2	16
	G 6	16
	G 25-2	16
	H 6-1	20
	K 6-1	24
	L 2	26
	N 17	30
	Q1 2-4	36
	Z2 42-26	44
012400432	A 27-4	2
	A 32	2
	G 29	16
	K 13	24
	M 5	28
	N 4-2	30
	N 16	30
	Q1 2-12	36
012400832	A 31	2
	G 32	16
012500532	N 2	30
014780622	Q2 3-1-1-6	38
	Q2 3-2-1-6	38
017060812	K 8	24
	L 7	26
017061612	C 1-3-1	8
	H 1-2-1	20
017081606	Q2 3-1-1-8	38
	Q2 3-2-1-8	38
017085502	Z2 64-5	44
017500812	H 26	20
017501212	A 64	4
017781412	Q2 3-1-1-4	38
	Q2 3-1-1-10	38
	Q2 3-1-1-13	38
	Q2 3-2-1-4	38
	Q2 3-2-1-10	38
	Q2 3-2-1-13	38
018061432	G 53	16
	K 10	24
	M 12-1	28
	M 14-1	28
	N 6	30
018061632	F1 22	12
	G 8-1	16
	G 34	16
	G 40-1	16
	G 60	18
018062532	B 28	6
	C 16	8
	F1 13	12
018400832	A 20	2
	G 48-2	16
018401222	Q1 1-2	36
018401622	C 1-1	8
	H 1-1	20
	K 1-1	24
	L 1-1	26

CODE	REF.NO	page
021060302	Q1 1-1-20	36
	Q1 1-7	36
021080106	Z1 33	42
	Z2 64-8	44
021400106	Z1 70	42
021400202	Q2 3-1-3	38
	Q2 3-2-3	38
021400212	A 53	4
	E 1-5	10
	F1 18	12
	Q1 1-1-22	36
021400432	Q1 2-10	36
021500216	M 9	28
021500312	Q1 2-18	36
025030132	F2 50-16-3	14
	H 14	20
025040132	G 49	16
	H 11-1	20
025040232	Q3 4-5	40
025040332	Z1 60	42
025050132	A 72	4
025060332	F1 14	12
025080236	Z2 64-6	44
025350332	A 68	4
	G 63	18
025660132	F2 50-10-4	14
025710232	G 12	16
	G 13	16
028050242	P 64	32
028050246	Z2 42-16	44
028060242	B 27	6
028080242	Z1 32	42
	Z2 64-7	44
031411304	Z1 57	42
031452206	Z2 42-31	44
034422006	Q3 4-6-2	40
047161042	F2 50-16-7	14
047301242	G 1-1	16
	G 1-2	16
047301642	F1 2-2	12
047401442	F1 21-1	12
047502542	F1 16	12
	G 57	18
047602042	A 54	4
048040342	G 14	16
048090342	F1 27	12
	G 19	16
048400242	B 14	6
060300412	F1 35	12
	P 30	32
060300512	Z1 92	42
060300612	F1 39	12
	P 52	32
060350812	A 67	4
	G 62	18
	M 28	28
060351012	L 15	26
060400512	A 60	4
060400612	A 12	2
	A 27-7	2
	A 27-9	2
	A 34	2
	A 36	2

CODE	REF.NO	page
060400612	A 46	2
	A 50	2
	A 59	4
	F1 10	12
	G 22	16
	J 8	22
	P 24	32
	P 32	32
	P 36	32
	P 39	32
	P 41	32
	P 43	32
	P 45	32
	P 54	32
	P 57	32
	P 76	34
060400812	A 15	2
	A 22-1	2
	H 29	20
	N 24	30
	Q1 2-14	30
	Q1 2-16	30
	Z2 64-11	44
	Z2 64-12	44
060401012	A 25-1	2
	D 1-3	10
060401412	A 28	2
	P 68	34
060630712	G 75-1	18
061400812	A 26	2
	B 6	6
	N 20	30
062060812	H 18	20
	H 21	20
062061412	Z1 66	42
062300412	H 16-2	20
062300512	E 1-7	10
062300612	M 17	28
062300812	C 28	8
	Q1 1-1-11	36
062350512	Q1 1-1-27	3
062350612	E 1-9	10
	P 70	34
062350812	C 7-3	8
	C 26	8
	Q1 2-5	36
062400612	A 30	2
	Q1 1-1-25	36
	Z1 59	42
062400812	A 9	2
	B 5	6
	N 4-6	30
	Q1 1-1-16	36
	Q3 4-4	40
062401012	A 4	2
	B 22	6
	C 20	8
	C 30	8
	E 2	10
	Q2 3-1-4	38
	Q2 3-2-4	38
062401212	A 52	4
	H 10-1	20

CODE	REF.NO	page
062401212	N 4-9	30
062401406	Z1 71	42
062401612	A 80	4
	Q1 1-1-21	36
062402512	H 10-2	20
062670712	F1 41	12
	F2 50-1-7	14
	F2 50-5-4	14
	F2 50-6-7	14
	F2 50-10-6	14
	F2 50-15-4	14
072600000	B 7	6
076203000	B 15	6
081005070	G 11	16
081005670	G 56	18
081009070	A 77	4
081014670	A 6	2
081020070	G 21	16
081031870	B 4	6
100032003	A 40	2
	C 33	8
100080004	F2 50-15-3	14
100136001	Q3 4-1-4	40
100315002	A 41	2
101118001	Q3 4-2	40
101572101	Z1 5	42
102707002	Q1 1-8	36
104450101	C 11	8
105161004	F1 3	12
105288001	F2 50-1-3	14
	F2 50-10-3	14
106640001	F2 50-5-3	14
	F2 50-10-5	14
108494001	Q3 4-1-2	40
108495001	Q3 4-1-3	40
110832009	P 12	32
	P 12	34
116016001	Z1 72	42
117466000	Z1 13	42
118550001	K 14	24
118735002	C 1-3-2	8
	H 1-2-2	20
122991001	Z1 25	42
125324001	H 11-2	20
126863021	Z2 42-18	44
140530002	F2 50-6-3	14
141183000	A 39	2
142002001	Z1 8	42
142262001	Z1 24	42
142999101	Z2 42-27	44
143767102	Q3 4-1	40
143980001	Q3 4-1-1	40
144074350	Ga1 7	45
	Ga2 7	46
	Ga3 7	47
	Ga4 7	48
	Ga5 7	49
	Ga6 7	50
	H 15-1	20
144103009	P 13	32
	P 13	34
144225002	Z1 41	42
144504001	P 60	32

CODE	REF.NO	page
144784001	Q1 1-1-10	42
146293001	C 6	32
146427001	C 12-1	36
	P 47	8
146592001	P 21	8
146598001	A 71	32
	E 1-3	32
146600001	E 1-8	4
147893009	Z1 69	10
147919051	Z1 48-1	10
147919052	Z1 48-2	42
147942001	N 8-1	42
	N 10-1	42
	N 13-1	30
148084001	N 18	30
148782001	L 13	30
	M 26	30
148797001	Q2 3-1-1-5	26
	Q2 3-2-1-5	28
148798109	Q2 3-1-1-7	38
	Q2 3-2-1-7	38
149570001	Z1 9	38
150172023	Z2 42-1	38
150173023	Z2 42-6	42
150179022	Z2 42-15	44
150180021	Z2 42-19	44
150182020	Z2 42-20	44
150185009	Z2 42-21	44
150188009	Z2 42-28	44
150194009	Z2 42-32	44
150206022	Z2 42-3	44
150755001	F2 50-16-4	44
150813001	P 69	44
151474011	Ga1 1	14
151474014	Ga1 1	34
151474016	Ga1 1	45
151474018	Ga1 1	45
153318201	Z2 64-2	45
155162001	C 7-6	45
	K 9-2-2	44
	M 12-2	8
	M 14-2	24
155197101	Q2 3-1-1-1	28
	Q2 3-2-1-1	28
155199101	Q2 3-1-1-3	38
	Q2 3-2-1-3	38
155247000	H 3	38
	K 11	38
	L 10	20
155261000	M 23	24
155510001	P 62	26
155559001	B 12	28
156482000	A 51	32
158782151	P 61	6
183797009	Z1 56	4
183798001	Z2 64-1	32
213650001	Z1 31	42
	Z2 64-9	44
500296002	F2 50-16-6	42
S00075000	A 66	44
S01943001	Z1 7	14
S02573020	G 38	16
S02606020	A 3	2

CODE	REF.NO	page
S02778022	Z2 42-9	44
S02779009	Z2 42-11	44
S02783001	Z2 42-27	44
S04109001	Z2 42-24	44
S06701000	Z1 18	42
S06704001	D 1-4	10
S19174001	Ga1 4	45
	Ga3 4	47
S19175001	Ga1 4	45
	Ga3 4	47
S19176001	Ga4 4	48
S19177001	Ga4 4	48
S19178001	Ga4 4	48
S19182001	Ga2 4	46
	Ga5 4	49
	Ga6 4	50
S19183001	Ga2 4	46
	Ga3 4	47
	Ga6 4	50
S19184001	Ga2 4	46
	Ga3 4	47
	Ga6 4	50
S19185001	Ga1 4	45
	Ga5 4	49
S19186001	Ga1 4	45
	Ga5 4	49
S19187001	Ga1 4	45
	Ga5 4	49
S19221201	Ga1 5	45
	Ga3 5	47
	Ga4 5	48
	Ga7 5	51
S19222201	Ga1 5	45
	Ga3 5	47
	Ga4 5	48
	Ga5 5	49
S19223101	Ga1 5	45
	Ga2 5	46
	Ga3 5	47
	Ga4 5	48
	Ga5 5	49
	Ga6 5	50
	Ga7 5	51
S19224201	Ga1 5	45
	Ga2 5	46
	Ga3 5	47
	Ga5 5	49
	Ga6 5	50
S19225201	Ga1 5	45
	Ga2 5	46
	Ga2 5	46
	Ga3 5	47
	Ga5 5	49
	Ga6 5	50
S19226101	Ga2 5	46
	Ga3 5	47
	Ga6 5	50
	Ga7 5	51
S19227101	Ga2 5	46
	Ga3 5	47
	Ga6 5	50
	Ga7 5	51
S19228101	Ga1 5	45

索引 / INDEX

CODE	REF.NO	page
S19228101	Ga4 5	48
	Ga5 5	49
S19229001	Ga1 5	45
	Ga4 5	48
S19245001	Ga5 5	49
	Ga1 6	45
S19246001	Ga3 6	47
	Ga4 6	48
	Ga7 6	51
	Ga1 6	45
S19247001	Ga2 6	46
	Ga3 6	47
	Ga5 6	49
	Ga6 6	50
S19304101	Ga1 6	45
	Ga5 6	49
S19307001	Ga1 2	45
	Ga3 2	47
S19308001	F2 50-1-4	14
	F2 50-6-4	14
S19309001	F2 50-1-5	14
	F2 50-6-5	14
S19311101	F2 50-1-6	14
	F2 50-6-6	14
S19312001	F2 50-1-1	14
	F2 50-5-1	14
	F2 50-6-1	14
	F2 50-10-1	14
	F2 50-15-1	14
S19313201	Ga1 2	45
	Ga3 2	47
	Ga4 2	48
	Ga7 2	51
S19317101	Ga1 2	45
	Ga4 2	48
S19321101	Ga1 2	45
	Ga2 2	46
S19325001	Ga2 2	46
	Ga5 2	49
	Ga6 2	50
	Ga7 2	51
	Ga2 2	46
S19326101	Ga2 2	46
	Ga6 2	50
S19330201	Ga2 2	46
	Ga6 2	50
S19334001	Ga1 2	45
	Ga5 2	49
S19340001	Ga1 2	45
	Ga4 2	48
	Ga5 2	49
S19368001	F2 50-16-2	14
S19497001	Ga2 4	46
	Ga5 4	49
S20115001	F1 38-2	12
S20117001	F1 38-3	12
S20118151	Z1 91	42
S20130009	Q3 4-6	40
S20131009	Q3 4-6-1	40
S20134001	Q3 4-6-1-1	40
S20135001	Q3 4-6-1-2	40
S20158101	P 72	34

CODE	REF.NO	page
S20199001	N 9	30
	N 14	30
S20231001	Ga1 4	45
	Ga2 4	46
	Ga4 4	48
	Ga6 4	50
S20232001	Ga1 4	45
	Ga2 4	46
	Ga4 4	48
S20233001	Ga6 4	50
	Ga2 4	46
	Ga4 4	48
S20234001	Ga6 4	50
	Ga1 4	45
	Ga4 4	48
S20235001	Ga1 4	45
	Ga2 4	46
	Ga4 4	48
S20236001	Ga6 4	50
	Ga1 4	45
	Ga2 4	46
	Ga4 4	48
S20239101	Ga6 4	50
	Ga1 5	45
	Ga2 5	46
	Ga4 5	48
	Ga6 5	50
S20240101	Ga7 5	51
	Ga1 5	45
	Ga2 5	46
S20241101	Ga4 5	48
	Ga6 5	50
	Ga7 5	51
	Ga1 5	45
S20242101	Ga2 5	46
	Ga4 5	48
	Ga6 5	50
	Ga1 5	45
S20243101	Ga2 5	46
	Ga4 5	48
	Ga6 5	50
	Ga1 5	45
S20244001	Ga2 5	46
	Ga4 5	48
	Ga6 5	50
	Ga1 6	45
S20245001	Ga2 6	46
	Ga4 6	48
	Ga6 6	50
	Ga1 6	45
S20310001	A 13	2
S20311000	A 14	2
S20319001	A 27-3	2
S20320101	A 27-5	2
S20321001	A 27-6	2
S20324101	A 33	2
S20325001	A 35	2
S20327101	A 27-8	2
S20338200	A 61	4
S20339000	A 62	4

CODE	REF.NO	page
S20340001	A 69	4
S20342001	A 70	4
	P 65	32
S20344001	A 74	4
S20345001	A 10	2
	A 75	4
S20346000	A 79	4
S20353000	B 21	6
S20355002	K 9-6	24
S20356001	B 11	6
S20361001	B 17	6
S20362151	B 18	6
S20391001	C 7-4	8
S20392000	C 7-5	8
	N 25	30
S20404001	Ga1 3	45
	Ga2 3	46
	Ga3 3	47
	Ga4 3	48
	Ga5 3	49
S20406001	Ga6 2	50
	Ga6 3	50
	Ga1 3	45
	Ga2 3	46
	Ga3 3	47
S20412000	Ga4 3	48
	Ga6 2	50
	Ga6 3	50
	A 48	2
	A 55	4
S20415101	Z1 67	42
	C 21	8
S20416101	C 22	8
S20418051	C 23	8
S20421001	Ga1 9	45
	Ga2 9	46
S20422001	Ga3 9	47
S20423001	Ga1 9	45
	Ga2 9	46
	Ga3 9	47
S20424001	Ga4 9	48
S20428001	Ga5 9	49
	Ga6 9	50
	Ga4 9	48
S20429001	Ga6 9	50
	Ga1 9	45
S20430001	Ga7 9	51
S20438101	Ga4 9	48
	Ga5 9	49
S20460000	D 1-1-1	10
S20468001	D 1-1	10
S20476001	F1 4	12
S20485001	F1 19	12
S20526000	G 47	16
S20530001	G 30	16
S20543101	G 51	16
S20544000	G 52	16
S20547001	G 55	16
S20548001	G 59	18
S20560001	G 66	18
S20571101	H 2	20
S20574001	H 8	20
S20577001	H 12	20

CODE	REF.NO	page
S20578101	H 13	20
S20579101	H 15-4	20
S20582001	Ga1 8	45
	Ga2 8	46
	Ga3 8	47
	Ga4 8	48
	Ga5 8	49
	Ga6 8	50
S20583001	Ga1 8	45
	Ga4 8	48
	Ga5 8	49
S20585001	H 27	20
S20589101	H 9-1	20
S20590101	H 9-2	20
S20591101	H 17	20
S20598000	K 2	24
	L 3	26
S20601001	K 5	24
S20625151	L 11	26
S20626001	L 14-1	26
S20627001	L 14-2	26
S20641001	M 11	28
S20652001	M 24	28
S20653001	M 27	28
S20654001	M 29	28
S20655101	N 1	30
S20657001	N 4-1	30
S20668200	N 19	30
S20669000	N 23	30
S20671000	N 22	30
S20673001	P 11	32
	P 11	34
S20675001	P 8	34
S20676051	P 9	32
	P 9	34
S20676051	Q1 1-1-5	36
S20677000	P 10	32
	P 10	34
S20678001	P 14	32
	P 14	34
S20679001	P 16	32
	P 17	32
S20681000	P 18	32
	P 18	34
	Q1 1-1-7	36
S20682101	P 19-2	32
S20682102	P 19-4	32
S20682103	P 19-1	32
S20682103	P 19-5	34
S20682104	P 19-3	32
S20682105	Q1 1-1-8	36
S20684101	P 23	32
S20685001	P 25	32
S20686001	P 26	32
S20687001	P 37	32
S20689001	P 48	32
S20690001	P 49	32
S20691001	P 50	32
S20694001	P 53	32
S20695001	P 55	32
S20696001	P 56	32
S20697001	P 58	32
S20698121	P 59	32

CODE	REF.NO	page
S20701001	P 66	32
S20702001	P 71	34
S20703051	P 73	34
S20707001	P 75	34
S20718000	Z1 27	42
S20721001	Z2 64-1	44
S20722001	Z2 64-10	44
S20723001	Z1 12	42
S20743001	P 51	32
S20769000	Z1 40	42
S20878000	A 81	4
S20882201	Ga2 2	46
	Ga6 2	50
S20896101	H 15-2	20
	Ga4 7	48
	Ga7 7	51
S20897101	H 15-3	20
S20898101	H 15-5	20
	Ga1 7	45
	Ga4 7	48
	Ga5 7	49
S20899001	Ga1 8	45
	Ga3 8	47
	Ga4 8	48
S21104001	Ga1 3	45
	Ga4 3	48
	Ga5 3	49
S21125001	P 44-1	32
S21126001	P 40-1	32
S21128001	P 44-2	34
S21129001	P 40-2	34
S21130051	P 42	32
S21133001	P 28	32
S21134001	P 29	32
S21135001	P 31	32
S21136101	P 35	32
S21137001	P 33	32
S21293001	Q1 1-1	36
S21294001	Q1 1-1-1	36
S21295001	Q1 1-1-2	36
S21296001	Q1 1-1-9	36
S21297001	Q1 1-1-12	36
S21298001	Q1 1-1-15	36
S21299001	Q1 1-1-17	36
S21300001	Q1 1-1-19	36
S21301001	Q1 1-1-23	36
S21302001	Q1 1-1-24	36
S21303001	Q1 1-1-26	36
S21304001	Q1 1-1-28	36
S21305001	Q1 1-1-3	36
S21306001	Q1 1-1-13	36
S21307001	Q1 1-1-14	36
S21310001	Q1 2-1	36
S21311001	Q1 2-2	36
S21312001	Q1 2-3	36
S21314001	Q1 2-7	36
S21315001	Q1 2-9	36
S21316001	Q1 2-11	36
S21318000	Q3 4-3	40
S21341001	E 1-6	10
S21373101	Q2 3-1-1	38
S21375001	Q2 3-1-1-2	38
	Q2 3-2-1-2	38

CODE	REF.NO	page
S21376001	Q2 3-1-1-9	38
	Q2 3-2-1-9	38
S21377001	Q2 3-1-1-11	38
	Q2 3-2-1-11	38
S21378001	Q2 3-1-1-12	38
	Q2 3-2-1-12	38
S21379001	Q2 3-1-2	38
S21380101	Q2 3-2-1	38
S21381001	Q2 3-2-2	38
S21590000	Q1 1-4	36
S23233001	Ga1 4	45
S23337001	A 7	2
	A 76	4
S23342001	C 1-2	8
	C 7-1	8
	H 1-3	20
	K 9-4	24
S23346101	K 1-2	24
S23349001	Q1 2-13	36
S23350001	A 63	4
S23351001	A 65	4
S23353001	Z1 58	42
S23356001	Z1 10	42
S23357001	A 78	4
S23360001	G 37	16
	G 42	16
	M 18	28
S23364000	F1 44	12
S23418002	D 1-2	10
	J 6	22
	P 27	32
	Q1 1-5	36
S23452002	P 22	32
	P 74	34
S23456101	C 24	8
	M 30	28
S23614101	L 12	26
	M 25	28
S23616101	A 25-2	2
S23621101	G 70	18
	G 76	18
	G 78	18
	H 16-1	20
S23626001	K 7	24
	L 6	26
S23628101	G 69	18
S23651002	Q1 1-1-18	36
	Q3 4-9	40
S23773001	E 1-2	10
S23774001	Q1 2-8	36
S23775001	Q1 1-1-6	36
S23777101	Q1 1-1-4	36
S23779001	Q1 1-6	36
S23896101	E 1-1	10
S23897001	E 1-4	10
S24473000	Z1 14	42
S25019001	Q3 4-8	40
S25184001	A 93	4
S25194001	Ga1 4	45
	Ga3 4	47
	Ga3 4	47
S25195001	Ga1 4	45
	Ga3 4	47

索引 / INDEX

CODE	REF.NO	page	CODE	REF.NO	page	CODE	REF.NO	page
S25196001	Ga1 4	45	S30532001	Ga5 2	49	S38311100	G 43	16
	Ga4 4	48	S30562000	F1 28	12	S38312050	G 24	16
S25197001	Ga1 4	45		G 18	16	S38328051	P 1	32
	Ga4 4	48	S30586101	Ga3 2	47	S38329001	P 38	32
S25198001	Ga1 4	45	S30588001	Ga4 2	48	S38330050	P 46	32
	Ga5 4	49	S30590001	F2 50-16-5	14	S38595001	Ga5 5	49
S25199001	Ga1 4	45	S30592101	Ga3 2	47	S38596001	Ga5 5	49
	Ga5 4	49	S30593001	Ga3 2	47	S38597001	Ga5 6	49
S25200001	Ga1 4	45		Ga4 2	48	S39562001	A 37	2
	Ga4 4	48	S30594101	Ga4 2	48	S39564021	A 23	2
S25201001	Ga1 4	45	S30888001	F1 40	12	S39565101	B 24-2	6
	Ga4 4	48	S30889001	F1 38-4	12	S39566001	C 7	8
S25202001	Ga3 4	47	S30890000	H 15-6	20	S39571021	C 10	8
	Ga7 4	51	S30971001	Ga1 2	45	S39574001	C 8	8
S25203001	Ga3 4	47		Ga2 2	46	S39575001	F1 2	12
	Ga7 4	51		Ga4 2	48	S39577000	F1 2-1	12
S25204001	Ga7 4	51		Ga6 2	50	S39578001	G 1	16
S25548101	Ga1 2	45		Ga6 2	50	S39585001	G 1-3	16
	Ga5 2	49	S31881101	M 12	28	S39586001	G 1-4	16
S25550001	Ga2 2	46	S31975001	Ga7 4	51	S39589021	G 8	7
	Ga6 2	50	S31979001	Ga7 4	51	S39593021	G 54	7
S25553001	Ga2 2	46	S31981001	Ga7 2	51	S39596021	G 54-1	10
	Ga3 2	47	S32140001	E 1	10	S39597001	N 4	30
	Ga6 2	50	S32276001	P 15	32	S39598000	N 4-4	30
	Ga7 2	51	S33172001	Ga1 5	45	S39599001	N 4-3	30
S25555001	Ga3 2	47		Ga2 5	46	S39601000	N 4-5	30
	Ga7 2	51		Ga3 5	47	S39602000	N 4-7	30
S25557001	Ga1 2	45		Ga4 5	48	S39603001	N 4-8	30
	Ga4 2	48		Ga5 5	49	S39605001	A 2	2
S25560101	Ga3 2	47		Ga6 5	50	S39606020	A 5	2
	Ga7 2	51		Ga7 5	51	S39607001	A 8	2
S25562101	Ga7 2	51		Ga6 5	50	S39608021	A 11	2
S25566001	Ga1 6	45	S35635020	Z2 42-5	44	S39611001	A 27	2
	Ga4 6	48	S35651001	Ga1 4	45	S39612001	A 27-1	2
S25818051	G 61	18		Ga4 4	48	S39613001	A 27-2	2
S27868001	B 16	6	S35826021	Z2 42-7	44	S39623001	A 38	2
S29102001	M 6	28		Z2 42-29	44	S39624021	A 42	2
S29146001	Ga1 3	45	S35827021	Z2 42-8	44	S39625151	A 49	2
S29148001	Ga7 3	51		Z2 42-10-2	44	S39626021	A 58	4
S29631001	Ga1 3	45		Z2 42-13	44	S39629021	B 3	F
	Ga4 3	48		Z2 42-14-2	44	S39630000	B 10	6
S29700000	K 9-3	24		Z2 42-17	44	S39631000	B 20	8
S29824000	J 4	22		Z2 42-23	44	S39644021	C 2	8
S29827000	J 4	22		Z2 42-30	44	S39645021	C 3	8
S29831000	J 7	22	S35831021	Z2 42-12	44	S39646021	C 4	8
S29835001	J 5	22		Z2 42-22	44	S39647000	C 5	8
S30135101	Q2 3-1	38	S35832021	Z2 42-10-1	44	S39648021	C 9	8
	Q3 3	40		Z2 42-14-1	44	S39649021	C 15	8
S30135102	Q2 3-2	38	S35840001	Ga4 5	48	S39650051	C 17	8
	Q3 3	40	S35991001	Ga4 5	48	S39652021	C 18	8
S30296001	Q3 5	40	S35992001	Ga4 6	48	S39654051	C 29	8
S30296002	Q3 5	40	S35997001	Z1 29	42	S39658001	F1 1	12
S30296003	Q3 5	40		Z2 64-3	44	S39659021	F1 6	12
S30296004	Q3 5	40	S36007001	Z2 64-4	44	S39660001	F1 7	12
S30296005	Q3 5	40	S36062021	Z2 42-4	44	S39661001	F1 8	12
S30296006	Q3 5	40	S36064021	Z2 42-2	44	S39662001	F1 9	12
S30297002	Q3 5	40	S37070121	F1 34	12	S39663121	F1 11	12
S30297004	Q3 5	40	S38301020	A 44	2	S39664101	F1 12	12
S30297006	Q3 5	40	S38302020	Z1 65	42	S39665001	F1 15	12
S30303001	Q3 4	40	S38305001	A 29-1	2	S39666001	F1 20	12
S30304001	Q1 1	36	S38306051	C 25	8	S39667021	F1 21	12
	Q3 1	40	S38307001	C 27	8	S39669101	F1 23	12
S30525001	Ga5 2	49	S38308121	F1 5	12	S39670000	F1 24	12

CODE	REF.NO	page
S39671121	F1 26	12
S39672001	F1 29	12
S39673020	G 5	16
S39674001	G 9	16
S39675001	G 10	16
S39676121	G 15	16
S39677021	G 16	16
	H 5	20
	K 4	24
	L 9	26
S39678021	G 17	16
S39679001	G 20	16
S39683000	G 26	16
S39684021	G 27	16
S39685001	G 28	16
S39686000	G 44	16
S39687000	G 45	16
S39688001	G 46	16
S39690021	G 36	16
	G 41	16
	M 8	28
S39691001	G 39	16
S39692021	G 50	16
S39693001	G 58	18
S39694021	G 64	18
S39695001	G 65	18
S39704021	H 4	20
S39707001	H 19	20
S39708001	H 25	20
S39709021	H 28	20
S39728021	K 3	24
	L 8	26
S39729021	M 1	28
S39732021	M 3	28
S39733001	M 4	28
S39734021	M 7	28
S39735050	M 10	28
S39740021	M 20	28
S39741021	M 21	28
S39742021	M 22	28
S39743001	N 3	30
S39744021	N 7	30
	N 12	30
S39745001	N 8	30
S39747001	N 10	30
S39749001	N 13	30
S39751021	N 11	30
S39752021	N 15	30
S39756021	P 63	32
S39757001	P 67	32
S39769051	G 40	16
S39770001	F1 17	12
S39773001	G 35	16
S39775001	B 24-1	6
S39785001	A 92	4
S39786001	A 92	4
S39787001	A 92	4
S39795001	Q1 2-6	36
S39796001	Q1 2-15	36
S42042021	G 33	16
S42050001	A 29-2	2
S43521000	N 29-1	30
S43522000	N 29-2	30

CODE	REF.NO	page
S43523000	N 29	30
S43525001	D 1	10
S43527001	H 6	20
	K 6	24
S43530001	Q1 2	36
	Q3 2	40
S43539001	Q3	40
S43539002	Q3	40
S43539003	Q3	40
S43539004	Q3	40
S43539005	Q3	40
S43539006	Q3	40
S43540004	Q3	40
S43540005	Q3	40
S43540006	Q3	40
S43541001	Q3	40
S43541002	Q3	40
S43541003	Q3	40
S43541004	Q3	40
S43541005	Q3	40
S43541006	Q3	40
S43542004	Q3	40
S43542005	Q3	40
S43542006	Q3	40
S43916001	G 48-1	16
S44535001	A 22-2	2
	A 25-3	2
S44536000	A 24	2
S44744001	F1 38-1	12
S44778000	A 19	2
S44779001	A 21	2
S44821001	A 94	4
S44935101	M 14	28
S44937101	M 15	28
S44939001	M 16	28
S44955001	G 25-1	16
S45953001	Z2 42	44
S45954001	Z2 42	44
S45961001	Z2 42-25	44
S45964001	Z2 42-14	44
S45970001	Z2 42-10	44
S46899001	C 7-2	8
	K 9-2-1	24
S46900001	B 13	6
S46903001	F1 30	12
	K 13	24
S46904001	L 5	26
S46907001	Z1 11	42
S49337000	N 21	30
S50091001	G 23	16
S52053001	K 9	24
S52054001	K 9-1	24
S52059001	K 9-5	24
S52060001	K 9-2	24
S52062001	K 9	24
S52063001	K 9-2	24
S53955001	F2 50-16-8	14
S54001001	B 1	6
S54002001	B 1	6
S54003001	C 1	8
S54006001	C 1	8
S54007001	C 1	8
S54011001	H 1	20

CODE	REF.NO	page
S54012001	K 1	24
S54015001	K 1	24
S54018001	L 1	26
S54019001	L 1	26
S55666002	Z1 19	42
S57922001	M 19	28

brother®

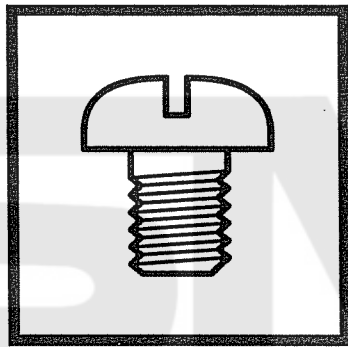

パーツブック
PARTS BOOK

ブラザー工業株式会社

BROTHER INDUSTRIES LTD

Printed in Japan

878-N31
S95N31-201
2002.02. (C)